

Ergebnis: **184.8** (174)  
 Serien: 89.5 95.3  
 Zähler: 4 9 5 1 1 0 0 0 0 0  
 Innenzehner: 2  
 Weitester: 1063 (1.), 835 (7.), 743 (16.)  
 beste Teiler: 122.6 (2.), 132.6 (11.), 217.9 (15.)  
 Trefferlage: 2.24 mm rechts, 0.72 mm hoch  
 Streuwert: 3.14, horizontal: 3.78, vertikal: 2.34

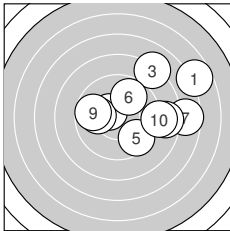
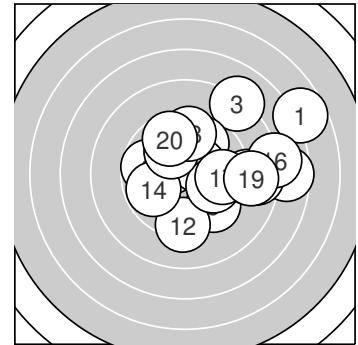

**Serie 1:**

6.7 ↗	10.5 *	8.1 ↗
9.8 ↗	7.6 →	8.6 →

beste Teiler: 122.6 (2.), 242.8 (4.), 285.9 (6.)  
 Trefferlage: 3.03 mm rechts, 1.15 mm hoch  
 Streuwert: 3.55, horizontal: 4.35, vertikal: 2.52

10.0 ←	9.6 ↘
9.7 ←	8.9 →

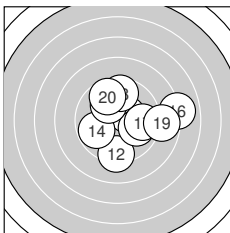

**Serie 2:**

10.4 *	9.3 ↓	9.9 ↘
8.0 →	9.7 →	9.6 ↑

beste Teiler: 132.6 (11.), 217.9 (15.), 251.2 (13.)  
 Trefferlage: 1.45 mm rechts, 0.30 mm hoch  
 Streuwert: 2.71, horizontal: 3.13, vertikal: 2.20

9.8 ←	10.1 ↘
8.8 →	9.7 ↗



Ergebnis: **163.2** (155)  
 Serien: 86.9 76.3  
 Zähler: 0 8 4 4 3 1 0 0 0 0  
 Innenzehner: 0  
 Weitest: 1286 (16.), 1248 (14.), 1042 (19.)  
 beste Teiler: 339.9 (6.), 366.0 (11.), 386.7 (3.)  
 Trefferlage: 1.58 mm rechts, 0.31 mm hoch  
 Streuwert: 5.38, horizontal: 6.01, vertikal: 4.67

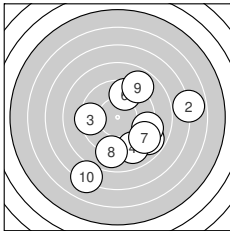
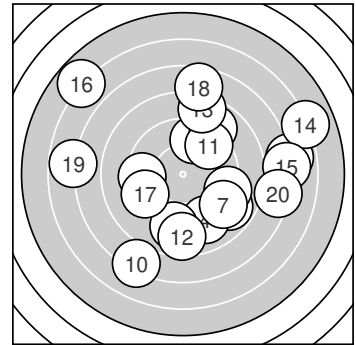

**Serie 1:**

8.8 ↘	6.9 →	9.4 ←	9.0 ↓	9.2 →
9.6 ↑	9.0 ↘	9.0 ↓	8.9 ↗	7.1 ↙

beste Teiler: 339.9 (6.), 386.7 (3.), 450.4 (5.)  
 Trefferlage: 1.93 mm rechts, 1.61 mm tief  
 Streuwert: 4.10, horizontal: 4.27, vertikal: 3.92

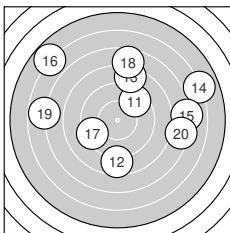

**Serie 2:**

9.5 ↗	8.6 ↓	8.4 ↑	6.0 →	7.0 →
5.8 ↘	9.3 ↙	7.6 ↑	6.8 ←	7.3 →

beste Teiler: 366.0 (11.), 404.3 (17.), 588.0 (12.)  
 Trefferlage: 1.24 mm rechts, 2.25 mm hoch  
 Streuwert: 6.33, horizontal: 7.60, vertikal: 4.72



Ergebnis: **345.8** (325)  
 Serien: 85.0 88.1 84.4 88.3  
 Zähler: 1 15 15 6 3 0 0 0 0 0  
 Innenzehner: 1  
 Weitester: 1246 (32.), 1056 (2.), 1004 (7.)  
 beste Teiler: 81.0 (9.), 261.5 (40.), 264.2 (34.)  
 Trefferlage: 1.09 mm rechts, 0.02 mm hoch  
 Streuwert: 4.46, horizontal: 4.68, vertikal: 4.23

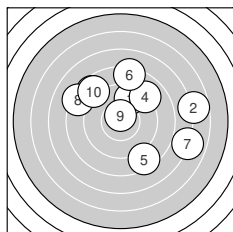
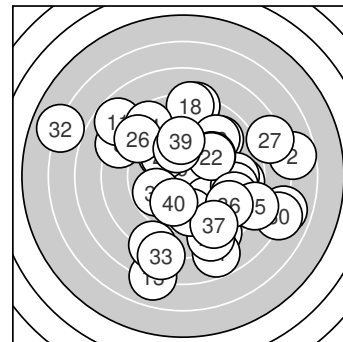

**Serie 1:**  
 9.6 ↗ 6.7 → 8.6 ↘ 9.0 ↗ 8.4 ↘  
 8.3 ↑ 6.9 → 8.2 ↘ 10.6 \* 8.7 ↘  
 beste Teiler: 81.0 (9.), 347.8 (1.), 490.7 (4.)  
 Trefferlage: 1.53 mm rechts, 1.90 mm hoch  
 Streuwert: 4.64, horizontal: 5.47, vertikal: 3.63

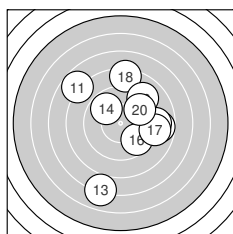

**Serie 2:**  
 7.8 ↘ 8.8 → 7.0 ↓ 9.8 ↘ 9.0 →  
 9.7 ↘ 9.0 → 8.3 ↑ 9.1 ↗ 9.6 ↗  
 beste Teiler: 287.8 (14.), 325.9 (16.), 334.6 (20.)  
 Trefferlage: 1.31 mm rechts, 0.61 mm hoch  
 Streuwert: 4.20, horizontal: 3.86, vertikal: 4.52

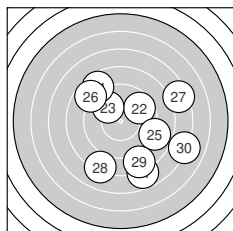

**Serie 3:**  
 7.8 ↘ 9.6 ↗ 9.9 ↘ 8.6 ↘ 8.9 →  
 8.7 ↘ 7.4 → 8.1 ↓ 8.4 ↘ 7.0 →  
 beste Teiler: 266.2 (23.), 326.2 (22.), 518.8 (25.)  
 Trefferlage: 1.84 mm rechts, 0.95 mm tief  
 Streuwert: 4.70, horizontal: 4.76, vertikal: 4.63

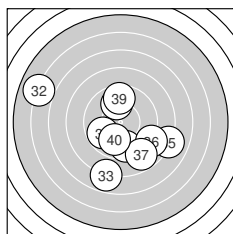

**Serie 4:**  
 9.6 ↓ 6.0 ↖ 7.8 ↓ 9.9 ↑ 8.0 →  
 8.9 ↘ 8.8 ↘ 9.8 ↖ 9.6 ↑ 9.9 ↓  
 beste Teiler: 261.5 (40.), 264.2 (34.), 294.8 (38.)  
 Trefferlage: 0.29 mm links, 1.45 mm tief  
 Streuwert: 4.41, horizontal: 4.95, vertikal: 3.81



Ergebnis: **373.9** (356)  
 Serien: 91.5 97.7 93.7 91.0  
 Zähler: 10 19 8 3 0 0 0 0 0 0  
 Innenzehner: 5  
 Weitester: 939 (6.), 769 (33.), 757 (24.)  
 beste Teiler: 69.6 (7.), 102.7 (27.), 109.2 (20.)  
 Trefferlage: 1.16 mm rechts, 0.38 mm hoch  
 Streuwert: 3.08, horizontal: 3.31, vertikal: 2.83

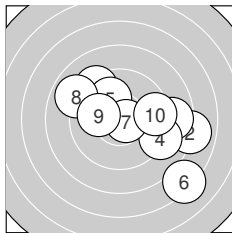
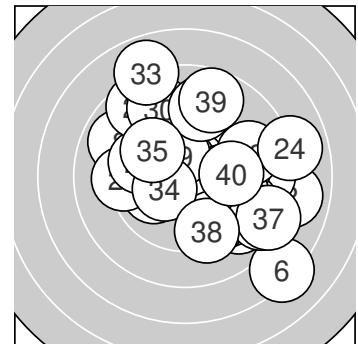

**Serie 1:**

9.3 ↘	8.0 →	8.8 →	9.1 →	10.0 ↘
7.2 ↘	10.7 *	8.9 ↘	10.1 ←	9.4 →

beste Teiler: 69.6 (7.), 222.3 (9.), 236.6 (5.)  
 Trefferlage: 1.80 mm rechts, 0.11 mm tief  
 Streuwert: 3.59, horizontal: 4.24, vertikal: 2.79

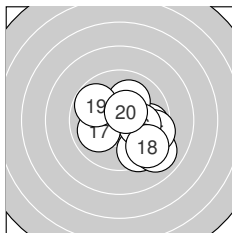

**Serie 2:**

9.5 ↘	9.8 →	10.1 ↑	9.0 ↘	9.5 →
10.1 →	10.0 ←	9.4 ↘	9.8 ↘	10.5 *

beste Teiler: 109.2 (20.), 213.4 (16.), 217.8 (13.)  
 Trefferlage: 1.41 mm rechts, 0.78 mm tief  
 Streuwert: 2.04, horizontal: 2.21, vertikal: 1.86

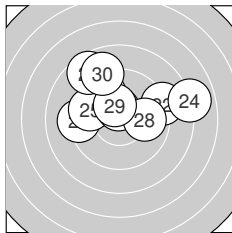

**Serie 3:**

9.2 ←	9.1 →	9.7 ↘	7.9 →	9.6 ←
8.6 ↘	10.5 *	9.9 →	10.3 *	8.9 ↘

beste Teiler: 102.7 (27.), 154.3 (29.), 262.0 (28.)  
 Trefferlage: 0.02 mm links, 1.90 mm hoch  
 Streuwert: 2.91, horizontal: 3.72, vertikal: 1.74

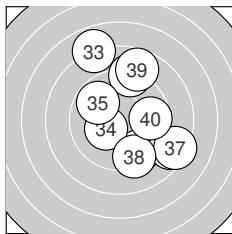

**Serie 4:**

9.4 ↘	9.0 ↑	7.9 ↘	10.3 *	9.8 ↘
8.5 ↘	8.4 ↘	9.3 ↘	8.7 ↑	9.7 →

beste Teiler: 167.0 (34.), 289.5 (35.), 323.5 (40.)  
 Trefferlage: 1.43 mm rechts, 0.54 mm hoch  
 Streuwert: 3.51, horizontal: 2.92, vertikal: 4.01



Ergebnis: **366.5** (349)  
 Serien: 90.2 90.9 92.1 93.3  
 Zähler: 9 17 10 2 2 0 0 0 0 0  
 Innenzehner: 7  
 Weitester: 1097 (27.), 1059 (3.), 879 (16.)  
 beste Teiler: 80.5 (37.), 89.1 (21.), 139.2 (39.)  
 Trefferlage: 0.56 mm links, 1.45 mm tief  
 Streuwert: 3.50, horizontal: 3.61, vertikal: 3.38

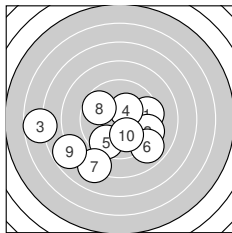
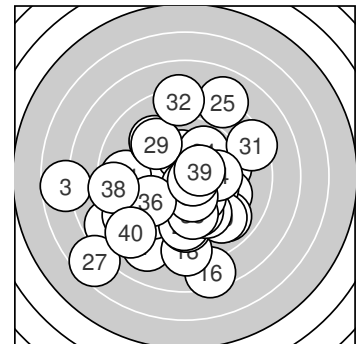

**Serie 1:**

9.5 →	9.3 →	6.7 ←	10.4 *	9.6 ↙
8.9 ↘	8.2 ↘	9.7 ↘	7.8 ↙	10.1 ↘

beste Teiler: 148.6 (4.), 225.6 (10.), 310.7 (8.)  
 Trefferlage: 1.22 mm links, 1.80 mm tief  
 Streuwert: 3.81, horizontal: 4.77, vertikal: 2.52

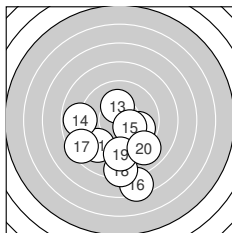

**Serie 2:**

9.2 ↙	9.9 →	10.2 *	8.9 ←	10.3 *
7.4 ↓	8.5 ↙	8.3 ↓	9.2 ↓	9.0 ↘

beste Teiler: 160.6 (15.), 186.2 (13.), 272.7 (12.)  
 Trefferlage: 0.39 mm links, 3.01 mm tief  
 Streuwert: 3.08, horizontal: 3.05, vertikal: 3.11

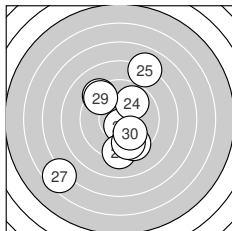

**Serie 3:**

10.6 *	9.2 ↓	9.3 ↘	9.9 ↗	8.0 ↗
9.5 ↘	6.6 ↙	9.6 ↓	9.4 ↘	10.0 ↘

beste Teiler: 89.1 (21.), 231.2 (30.), 273.4 (24.)  
 Trefferlage: 0.37 mm links, 0.62 mm tief  
 Streuwert: 3.79, horizontal: 3.28, vertikal: 4.23

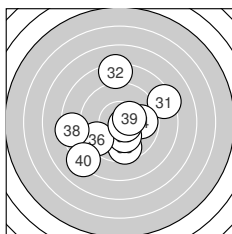

**Serie 4:**

8.3 →	8.3 ↑	9.6 ↓	9.8 →	10.2 *
9.5 ↙	10.6 *	8.4 ←	10.4 *	8.2 ↙

beste Teiler: 80.5 (37.), 139.2 (39.), 190.7 (35.)  
 Trefferlage: 0.25 mm links, 0.37 mm tief  
 Streuwert: 3.46, horizontal: 3.62, vertikal: 3.28



Ergebnis: **380.5** (360)  
 Serien: 94.9 93.5 95.9 96.2  
 Zähler: 10 21 8 1 0 0 0 0 0 0  
 Innenzehner: 8  
 Weitester: 800 (36.), 696 (1.), 669 (23.)  
 beste Teiler: 64.8 (33.), 73.1 (8.), 84.1 (21.)  
 Trefferlage: 0.08 mm rechts, 0.28 mm hoch  
 Streuwert: 2.89, horizontal: 3.30, vertikal: 2.41

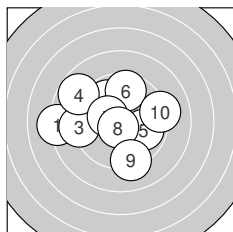
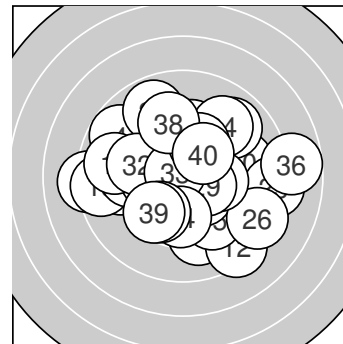

**Serie 1:**  
 8.2 ←                      9.9 ↘                      9.1 ←                      8.8 ↖                      9.9 →  
 9.6 ↑                      10.3 \*                      10.7 \*                      9.2 ↓                      9.2 →  
 beste Teiler: 73.1 (8.), 151.9 (7.), 268.9 (5.)  
 Trefferlage: 1.07 mm links, 0.33 mm hoch  
 Streuwert: 2.94, horizontal: 3.49, vertikal: 2.26

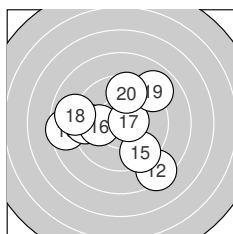

**Serie 2:**  
 9.7 ↑                      8.4 ↘                      8.5 ←                      9.4 ←                      9.4 ↘  
 10.0 ←                      10.6 \*                      8.9 ←                      9.0 ↗                      9.6 ↑  
 beste Teiler: 90.9 (17.), 236.1 (16.), 314.7 (11.)  
 Trefferlage: 0.49 mm links, 0.17 mm hoch  
 Streuwert: 3.20, horizontal: 3.56, vertikal: 2.79

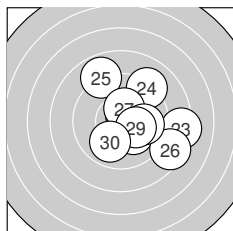

**Serie 3:**  
 10.6 \*                      10.2 \*                      8.3 →                      9.1 ↗                      8.9 ↘  
 8.4 ↘                      10.4 \*                      9.9 →                      10.2 \*                      9.9 ↙  
 beste Teiler: 84.1 (21.), 146.5 (27.), 180.3 (29.)  
 Trefferlage: 1.83 mm rechts, 0.18 mm hoch  
 Streuwert: 2.61, horizontal: 2.72, vertikal: 2.49

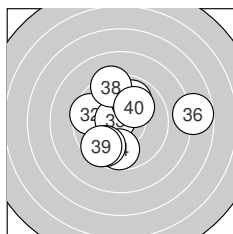

**Serie 4:**  
 9.7 ↑                      9.6 ←                      10.7 \*                      9.8 ↓                      9.9 ↗  
 7.8 →                      9.7 ↙                      9.3 ↑                      9.6 ↘                      10.1 ↗  
 beste Teiler: 64.8 (33.), 222.3 (40.), 266.1 (35.)  
 Trefferlage: 0.07 mm rechts, 0.46 mm hoch  
 Streuwert: 2.81, horizontal: 3.12, vertikal: 2.47



Ergebnis: **348.7** (329)  
 Serien: 87.2 89.4 91.0 81.1  
 Zähler: 5 10 16 7 2 0 0 0 0 0  
 Innenzehner: 4  
 Weitestе: 1118 (2.), 1020 (35.), 980 (8.)  
 beste Teiler: 61.2 (1.), 164.7 (21.), 167.8 (5.)  
 Trefferlage: 1.31 mm links, 0.14 mm tief  
 Streuwert: 4.28, horizontal: 4.66, vertikal: 3.87

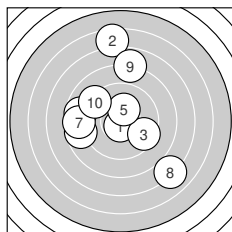
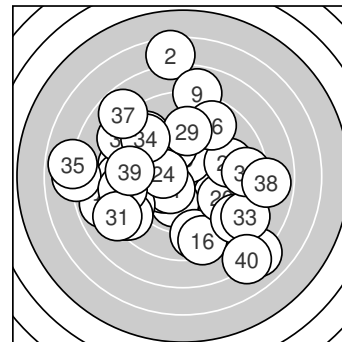

**Serie 1:**  
 10.7 \*                      6.5 ↑                      9.5 ↘                      8.7 ←                      10.3 \*  
    8.7 ←                      8.7 ←                      7.0 ↘                      7.9 ↑                      9.2 ↘  
 beste Teiler: 61.2 (1.), 167.8 (5.), 365.6 (3.)  
 Trefferlage: 0.97 mm links, 1.31 mm hoch  
 Streuwert: 4.64, horizontal: 4.19, vertikal: 5.06

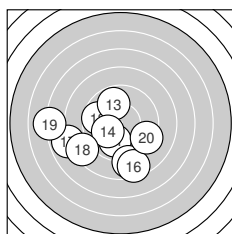

**Serie 2:**  
 9.9 ↓                      9.7 ←                      9.8 ↗                      10.1 ←                      8.8 ↓  
    8.5 ↓                      7.9 ←                      8.4 ↙                      7.0 ←                      9.3 ↘  
 beste Teiler: 209.9 (14.), 254.2 (11.), 284.6 (13.)  
 Trefferlage: 2.25 mm links, 1.95 mm tief  
 Streuwert: 3.50, horizontal: 4.18, vertikal: 2.64



**Serie 3:**  
 10.3 \*                      8.9 ↘                      8.8 ↙                      10.2 \*                      9.2 →  
    8.8 ↗                      8.5 ↙                      8.7 ←                      9.3 ↑                      8.3 ↘  
 beste Teiler: 164.7 (21.), 182.4 (24.), 415.9 (29.)  
 Trefferlage: 2.01 mm links, 0.88 mm hoch  
 Streuwert: 3.27, horizontal: 3.52, vertikal: 3.01

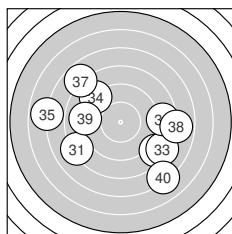

**Serie 4:**  
 8.1 ↙                      8.5 ↘                      8.2 ↘                      9.0 ↘                      6.9 ←  
    8.6 →                      7.8 ↘                      7.9 →                      9.0 ←                      7.1 ↘  
 beste Teiler: 488.6 (34.), 490.4 (39.), 581.2 (36.)  
 Trefferlage: 0.01 mm links, 0.83 mm tief  
 Streuwert: 5.42, horizontal: 6.57, vertikal: 3.95



**Ergebnis:** **364.6** (344)  
**Serien:** 90.6 93.3 89.9 90.8  
**Zähler:** 5 20 10 4 1 0 0 0 0 0  
**Innenzehner:** 4  
**Weiteste:** 1146 (24.), 945 (23.), 909 (3.)  
**beste Teiler:** 66.4 (28.), 80.4 (22.), 176.0 (26.)  
**Trefferlage:** 0.16 mm links, 0.43 mm tief  
**Streuwert:** 3.68, horizontal: 4.14, vertikal: 3.16

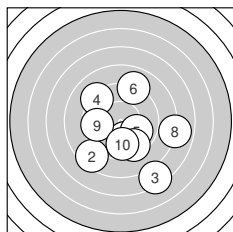
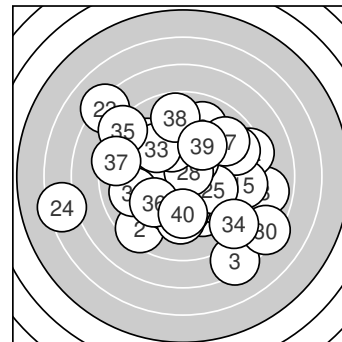

**Serie 1:**  
 10.0 ↓                      8.5 ↙                      7.3 ↘                      9.2 ↖                      9.9 →  
    9.0 ↑                      9.5 ↓                      7.9 →                      9.6 ←                      9.7 ↓  
**beste Teiler:** 236.2 (1.), 257.0 (5.), 313.0 (10.)  
**Trefferlage:** 0.84 mm rechts, 1.67 mm tief  
**Streuwert:** 3.61, horizontal: 3.65, vertikal: 3.57

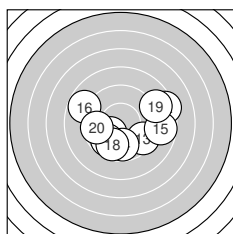

**Serie 2:**  
 10.2 \*                      8.4 →                      9.5 ↘                      9.8 ↓                      8.7 →  
    8.8 ↖                      9.8 ↙                      9.7 ↓                      8.8 →                      9.6 ←  
**beste Teiler:** 193.0 (11.), 296.1 (14.), 298.6 (17.)  
**Trefferlage:** 0.71 mm rechts, 0.62 mm tief  
**Streuwert:** 3.15, horizontal: 3.92, vertikal: 2.14

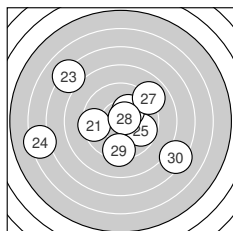

**Serie 3:**  
 9.5 ←                      10.6 \*                      7.2 ↖                      6.4 ←                      9.7 →  
    10.2 \*                      8.9 ↗                      10.7 \*                      9.4 ↓                      7.3 ↘  
**beste Teiler:** 66.4 (28.), 80.4 (22.), 176.0 (26.)  
**Trefferlage:** 0.56 mm links, 0.17 mm tief  
**Streuwert:** 4.52, horizontal: 5.44, vertikal: 3.34

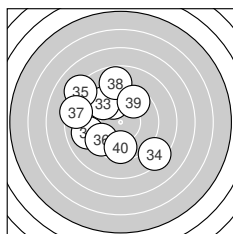

**Serie 4:**  
 9.8 ↖                      9.0 ←                      9.5 ↖                      8.4 ↘                      8.2 ↖  
    9.5 ↙                      8.4 ←                      8.8 ↑                      9.6 ↗                      9.6 ↓  
**beste Teiler:** 284.3 (31.), 333.4 (39.), 344.0 (40.)  
**Trefferlage:** 1.65 mm links, 0.73 mm hoch  
**Streuwert:** 3.37, horizontal: 3.35, vertikal: 3.40





Ergebnis: **376.2** (362)  
 Serien: 94.4 94.0 96.0 91.8  
 Zähler: 12 18 10 0 0 0 0 0 0 0  
 Innenzehner: 4  
 Weitester: 750 (9.), 728 (32.), 715 (13.)  
 beste Teiler: 92.4 (10.), 128.0 (24.), 128.0 (36.)  
 Trefferlage: 0.13 mm links, 0.03 mm hoch  
 Streuwert: 3.04, horizontal: 3.33, vertikal: 2.71

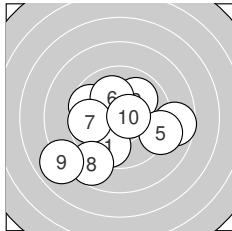
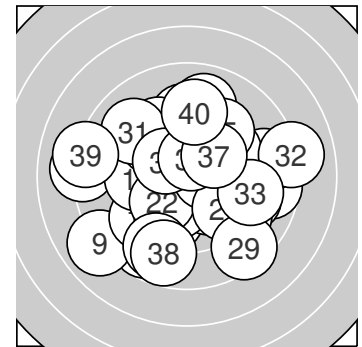

**Serie 1:**  
 9.7 ↙ 10.0 ↗ 9.7 ↖ 8.7 → 9.2 →  
 10.1 ↘ 9.7 ← 8.7 ↘ 8.0 ↙ 10.6 \*  
 beste Teiler: 92.4 (10.), 215.6 (6.), 247.7 (2.)  
 Trefferlage: 0.43 mm links, 0.98 mm tief  
 Streuwert: 3.06, horizontal: 3.58, vertikal: 2.45

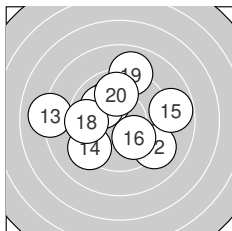

**Serie 2:**  
 10.1 ↘ 9.2 ↘ 8.1 ← 9.3 ↙ 8.8 →  
 10.0 ↘ 10.0 ↘ 9.6 ← 9.0 ↑ 9.9 ↑  
 beste Teiler: 210.7 (11.), 227.0 (17.), 229.4 (16.)  
 Trefferlage: 0.54 mm links, 0.46 mm hoch  
 Streuwert: 3.07, horizontal: 3.61, vertikal: 2.42

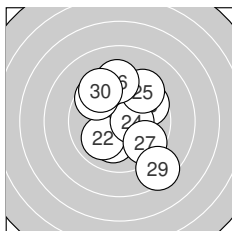

**Serie 3:**  
 10.1 ↙ 10.0 ↙ 9.6 ↗ 10.4 \* 9.4 ↗  
 9.3 ↑ 9.6 ↘ 9.6 ↘ 8.5 ↘ 9.5 ↘  
 beste Teiler: 128.0 (24.), 213.4 (21.), 240.4 (22.)  
 Trefferlage: 0.60 mm rechts, 0.35 mm hoch  
 Streuwert: 2.64, horizontal: 2.27, vertikal: 2.95

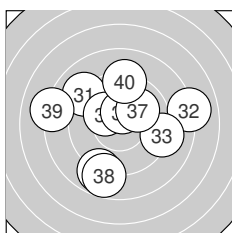

**Serie 4:**  
 9.0 ↘ 8.0 → 9.2 → 8.9 ↙ 10.2 \*  
 10.4 \* 10.0 ↗ 8.8 ↙ 8.1 ← 9.2 ↑  
 beste Teiler: 128.0 (36.), 179.4 (35.), 233.8 (37.)  
 Trefferlage: 0.16 mm links, 0.29 mm hoch  
 Streuwert: 3.59, horizontal: 4.00, vertikal: 3.13



**Ergebnis:** **394.0** (378)  
**Serien:** 100.9 94.1 99.5 99.5  
**Zähler:** 22 15 2 1 0 0 0 0 0 0  
**Innenzehner:** 15  
**Weiteste:** 822 (15.), 722 (21.), 630 (14.)  
**beste Teiler:** 8.2 (13.), 51.6 (32.), 62.9 (2.)  
**Trefferlage:** 1.50 mm links, 0.84 mm tief  
**Streuwert:** 1.98, horizontal: 2.33, vertikal: 1.57

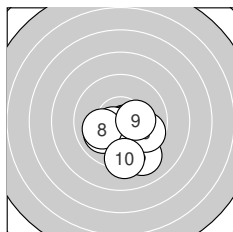
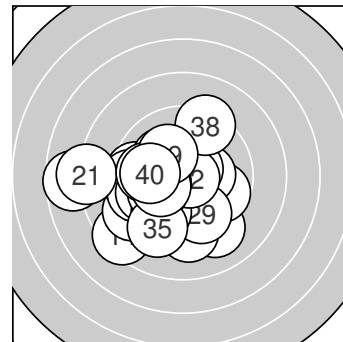

**Serie 1:**  
 10.6 \*                      10.7 \*                      10.0 ↙                      10.6 \*                      9.1 ↘  
 9.7 ↘                      10.5 \*                      10.1 ↙                      10.3 \*                      9.3 ↓  
**beste Teiler:** 62.9 (2.), 80.4 (4.), 89.3 (1.)  
**Trefferlage:** 0.43 mm rechts, 1.33 mm tief  
**Streuwert:** 1.56, horizontal: 1.65, vertikal: 1.47

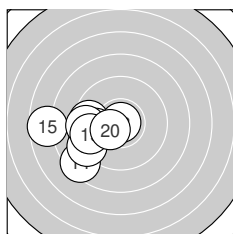

**Serie 2:**  
 9.5 ←                      9.8 ←                      10.9 \*                      8.4 ↙                      7.7 ←  
 9.4 ←                      9.1 ↙                      9.4 ←                      9.5 ←                      10.4 \*  
**beste Teiler:** 8.2 (13.), 137.3 (20.), 286.7 (12.)  
**Trefferlage:** 3.49 mm links, 1.11 mm tief  
**Streuwert:** 1.83, horizontal: 2.16, vertikal: 1.42

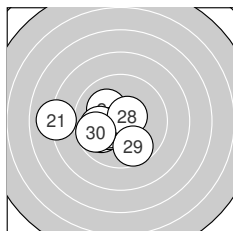

**Serie 3:**  
 8.1 ←                      10.6 \*                      10.0 ↙                      10.1 ↘                      10.3 \*  
 10.4 \*                      10.0 ←                      10.6 \*                      9.7 ↘                      9.7 ↙  
**beste Teiler:** 78.0 (22.), 92.4 (28.), 147.8 (26.)  
**Trefferlage:** 1.68 mm links, 0.62 mm tief  
**Streuwert:** 1.85, horizontal: 2.36, vertikal: 1.13

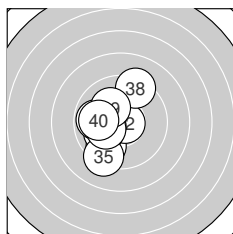

**Serie 4:**  
 9.7 ↙                      10.7 \*                      10.3 \*                      10.1 ↙                      9.2 ↙  
 9.8 ←                      10.2 \*                      9.3 ↗                      10.2 \*                      10.0 ←  
**beste Teiler:** 51.6 (32.), 170.0 (33.), 182.9 (37.)  
**Trefferlage:** 1.29 mm links, 0.31 mm tief  
**Streuwert:** 1.78, horizontal: 1.36, vertikal: 2.11



Ergebnis: **410.4** (393)  
 Serien: 104.1 102.9 101.6 101.8  
 Zähler: 33 7 0 0 0 0 0 0 0  
 Innenzehner: 24  
 Weitester: 309 (22.), 297 (24.), 286 (16.)  
 beste Teiler: 21.0 (8.), 54.5 (11.), 66.0 (1.)  
 Trefferlage: 0.08 mm links, 0.33 mm tief  
 Streuwert: 1.33, horizontal: 1.47, vertikal: 1.18

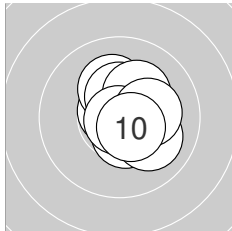
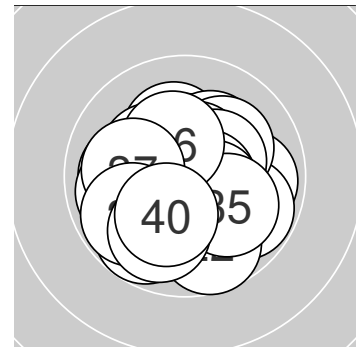

**Serie 1:**

10.7 *	10.3 *	10.5 *	10.1 ↘	10.2 *
10.4 *	10.2 *	10.9 *	10.2 *	10.6 *

beste Teiler: 21.0 (8.), 66.0 (1.), 97.8 (10.)  
 Trefferlage: 0.61 mm rechts, 0.14 mm hoch  
 Streuwert: 1.01, horizontal: 0.90, vertikal: 1.12

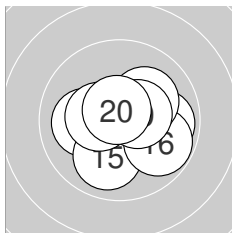

**Serie 2:**

10.7 *	10.1 ←	10.7 *	9.9 →	10.0 ↓
9.8 ↘	10.4 *	10.1 ↗	10.5 *	10.7 *

beste Teiler: 54.5 (11.), 69.6 (20.), 73.3 (13.)  
 Trefferlage: 0.39 mm rechts, 0.20 mm tief  
 Streuwert: 1.35, horizontal: 1.62, vertikal: 1.02

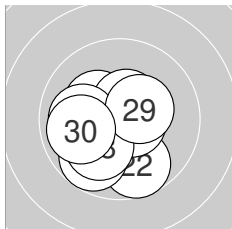

**Serie 3:**

10.3 *	9.7 ↓	10.3 *	9.8 ✓	10.5 *
10.6 *	10.0 ←	10.1 ✓	10.4 *	9.9 ←

beste Teiler: 82.2 (26.), 109.7 (25.), 145.7 (29.)  
 Trefferlage: 0.73 mm links, 0.56 mm tief  
 Streuwert: 1.43, horizontal: 1.47, vertikal: 1.38

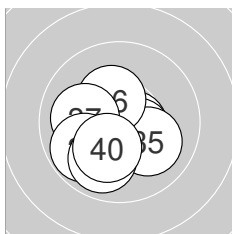

**Serie 4:**

10.6 *	10.4 *	10.1 ←	10.4 *	10.1 ↘
10.3 *	10.0 ←	9.8 ✓	9.9 ↓	10.2 *

beste Teiler: 87.3 (31.), 132.2 (32.), 148.8 (34.)  
 Trefferlage: 0.61 mm links, 0.70 mm tief  
 Streuwert: 1.32, horizontal: 1.47, vertikal: 1.15



Ergebnis: **407.7** (387)  
 Serien: 102.9 97.8 102.8 104.2  
 Zähler: 28 11 1 0 0 0 0 0 0 0  
 Innenzehner: 26  
 Weitestе: 548 (16.), 448 (5.), 410 (14.)  
 beste Teiler: 29.9 (6.), 31.6 (33.), 45.2 (22.)  
 Trefferlage: 1.14 mm links, 0.27 mm hoch  
 Streuwert: 1.38, horizontal: 1.59, vertikal: 1.14

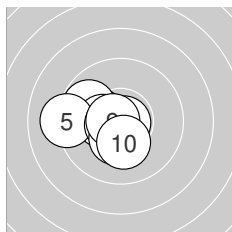
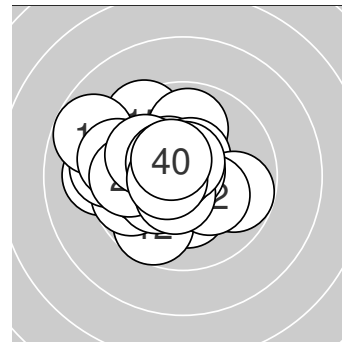

**Serie 1:**  
 10.6 \*                      10.2 \*                      9.8 ↖                      10.4 \*                      9.2 ←  
 10.8 \*                      10.6 \*                      10.4 \*                      10.7 \*                      10.2 \*  
 beste Teiler: 29.9 (6.), 65.1 (9.), 82.2 (7.)  
 Trefferlage: 1.26 mm links, 0.19 mm tief  
 Streuwert: 1.18, horizontal: 1.44, vertikal: 0.85

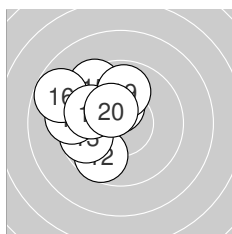

**Serie 2:**  
 10.3 \*                      9.7 ↙                      9.7 ←                      9.3 ←                      9.4 ↘  
 8.8 ↖                      9.9 ↖                      10.4 \*                      9.9 ↑                      10.4 \*  
 beste Teiler: 133.8 (20.), 143.8 (18.), 170.1 (11.)  
 Trefferlage: 2.02 mm links, 0.93 mm hoch  
 Streuwert: 1.69, horizontal: 1.65, vertikal: 1.73

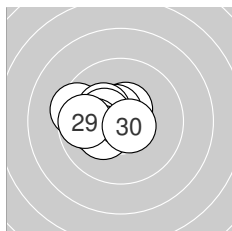

**Serie 3:**  
 9.4 ↖                      10.8 \*                      10.5 \*                      10.6 \*                      10.3 \*  
 10.4 \*                      10.1 ←                      10.3 \*                      9.8 ←                      10.6 \*  
 beste Teiler: 45.2 (22.), 81.4 (30.), 94.0 (24.)  
 Trefferlage: 1.19 mm links, 0.26 mm hoch  
 Streuwert: 1.15, horizontal: 1.48, vertikal: 0.69

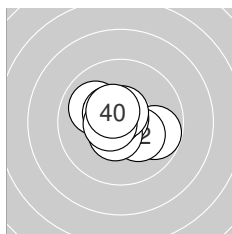

**Serie 4:**  
 9.8 ↗                      10.2 \*                      10.8 \*                      10.5 \*                      10.7 \*  
 10.6 \*                      10.0 ↖                      10.5 \*                      10.6 \*                      10.5 \*  
 beste Teiler: 31.6 (33.), 57.7 (35.), 79.4 (36.)  
 Trefferlage: 0.10 mm links, 0.11 mm hoch  
 Streuwert: 1.14, horizontal: 1.38, vertikal: 0.83



Ergebnis: **375.0** (359)  
 Serien: 94.2 92.5 91.8 96.5  
 Zähler: 10 22 5 3 0 0 0 0 0 0  
 Innenzehner: 5  
 Weitestе: 838 (30.), 794 (18.), 790 (24.)  
 beste Teiler: 125.2 (23.), 154.7 (28.), 173.9 (33.)  
 Trefferlage: 1.38 mm rechts, 1.22 mm tief  
 Streuwert: 2.82, horizontal: 3.18, vertikal: 2.40

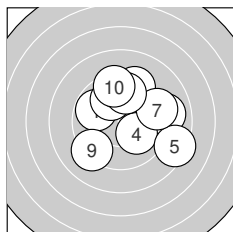
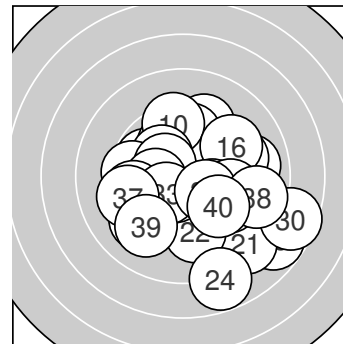

**Serie 1:**  
 9.8 ↖                      9.0 →                      9.9 ↗  
 9.4 ↗                      9.3 →                      9.7 ↑  
 beste Teiler: 217.6 (4.), 256.4 (3.), 289.9 (1.)  
 Trefferlage: 1.09 mm rechts, 0.90 mm hoch  
 Streuwert: 2.81, horizontal: 3.08, vertikal: 2.52

10.1 ↘                      8.4 →  
 9.2 ↙                      9.4 ↑

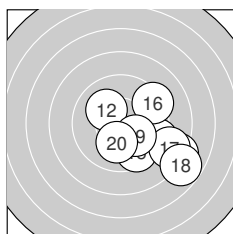

**Serie 2:**  
 9.2 ↘                      10.1 ↖                      8.1 ↘  
 9.3 ↗                      8.6 ↘                      7.8 ↘  
 beste Teiler: 210.1 (12.), 210.1 (19.), 210.2 (20.)  
 Trefferlage: 2.85 mm rechts, 1.79 mm tief  
 Streuwert: 2.43, horizontal: 2.71, vertikal: 2.10

9.6 ↘                      9.6 ↘  
 10.1 ↘                      10.1 ↓

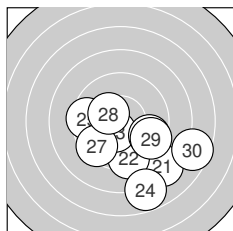

**Serie 3:**  
 8.3 ↘                      9.3 ↓                      10.5 \*  
 9.6 ↘                      9.5 ↙                      10.3 \*  
 beste Teiler: 125.2 (23.), 154.7 (28.), 347.4 (26.)  
 Trefferlage: 1.42 mm rechts, 2.54 mm tief  
 Streuwert: 3.04, horizontal: 3.53, vertikal: 2.46

7.8 ↓                      9.5 ←  
 9.4 ↘                      7.6 →

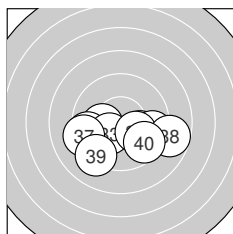

**Serie 4:**  
 10.2 \*                      9.5 ←                      10.3 \*  
 10.2 \*                      9.3 ←                      8.7 →  
 beste Teiler: 173.9 (33.), 196.6 (36.), 199.5 (31.)  
 Trefferlage: 0.16 mm rechts, 1.44 mm tief  
 Streuwert: 2.38, horizontal: 3.24, vertikal: 0.90

10.0 ↘                      9.5 →  
 9.2 ↙                      9.6 ↘



Ergebnis: **381.7** (364)  
 Serien: 90.6 96.1 99.2 95.8  
 Zähler: 17 14 6 2 1 0 0 0 0 0  
 Innenzehner: 11  
 Weitester: 1193 (4.), 782 (2.), 765 (5.)  
 beste Teiler: 7.0 (24.), 73.2 (34.), 125.8 (19.)  
 Trefferlage: 0.01 mm rechts, 0.43 mm hoch  
 Streuwert: 2.98, horizontal: 3.70, vertikal: 2.02

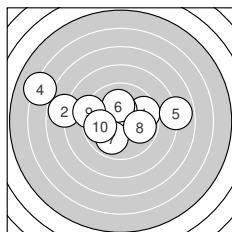
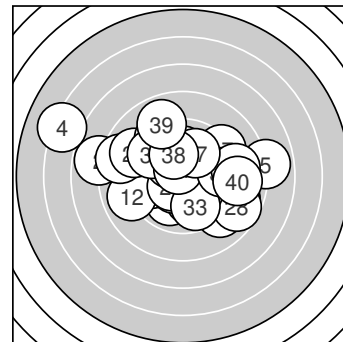

**Serie 1:**  
 9.6 →                      7.8 ←                      10.3 \*                      6.2 ←                      7.9 →  
 10.1 ↑                      9.9 ↘                      9.9 →                      9.1 ←                      9.8 ←  
 beste Teiler: 153.0 (3.), 214.4 (6.), 256.7 (7.)  
 Trefferlage: 1.40 mm links, 0.94 mm hoch  
 Streuwert: 4.05, horizontal: 5.42, vertikal: 1.84

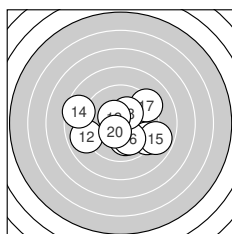

**Serie 2:**  
 10.0 ↓                      8.9 ←                      9.3 ↘                      8.6 ←                      8.9 →  
 10.0 ↓                      9.2 ↗                      10.3 \*                      10.5 \*                      10.4 \*  
 beste Teiler: 125.8 (19.), 139.2 (20.), 161.7 (18.)  
 Trefferlage: 0.25 mm rechts, 0.51 mm tief  
 Streuwert: 2.77, horizontal: 3.45, vertikal: 1.86

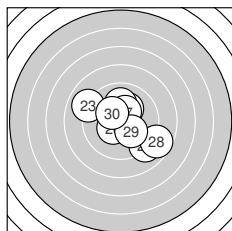

**Serie 3:**  
 10.2 \*                      10.0 ↑                      9.0 ←                      10.9 \*                      9.1 ↘  
 10.4 \*                      10.4 \*                      8.7 ↘                      10.2 \*                      10.3 \*  
 beste Teiler: 7.0 (24.), 137.3 (26.), 142.6 (27.)  
 Trefferlage: 0.46 mm rechts, 0.01 mm hoch  
 Streuwert: 2.32, horizontal: 2.56, vertikal: 2.04

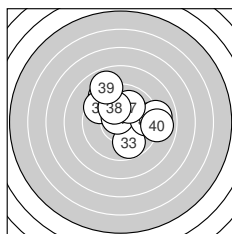

**Serie 4:**  
 9.3 ↘                      9.6 ↘                      9.8 ↓                      10.7 \*                      9.5 →  
 9.0 →                      10.0 ↗                      10.1 ↘                      8.9 ↗                      8.9 →  
 beste Teiler: 73.2 (34.), 215.0 (38.), 238.4 (37.)  
 Trefferlage: 0.73 mm rechts, 1.28 mm hoch  
 Streuwert: 2.52, horizontal: 2.89, vertikal: 2.09



**Ergebnis:** **385.9** (369)  
**Serien:** 93.9 99.1 98.4 94.5  
**Zähler:** 15 19 6 0 0 0 0 0 0 0  
**Innenzehner:** 8  
**Weiteste:** 607 (17.), 568 (38.), 537 (4.)  
**beste Teiler:** 50.4 (23.), 102.7 (19.), 104.2 (20.)  
**Trefferlage:** 0.97 mm links, 0.51 mm hoch  
**Streuwert:** 2.42, horizontal: 2.65, vertikal: 2.16

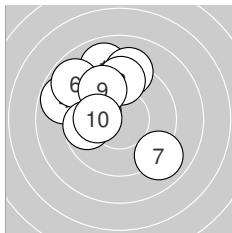
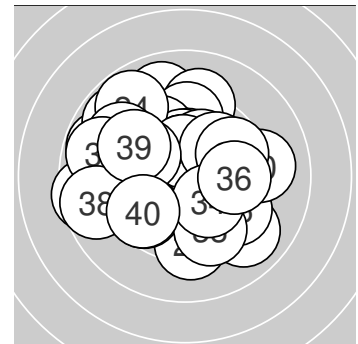

**Serie 1:**

9.0 ↑	9.2 ↑	9.5 ↑	8.8 ↖	10.1 ↖
8.8 ↘	9.0 ↘	9.7 ←	9.7 ↘	10.1 ←

**beste Teiler:** 204.1 (10.), 225.2 (5.), 304.0 (8.)  
**Trefferlage:** 1.47 mm links, 1.75 mm hoch  
**Streuwert:** 2.52, horizontal: 2.50, vertikal: 2.53

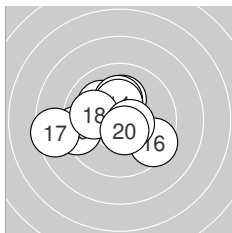

**Serie 2:**

10.2 *	10.1 ↘	10.2 *	10.3 *	9.3 ←
9.5 ↘	8.5 ←	10.0 ←	10.5 *	10.5 *

**beste Teiler:** 102.7 (19.), 104.2 (20.), 153.4 (14.)  
**Trefferlage:** 0.94 mm links, 0.18 mm hoch  
**Streuwert:** 2.11, horizontal: 2.61, vertikal: 1.45

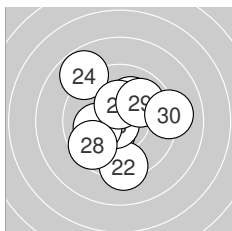

**Serie 3:**

10.4 *	9.3 ↓	10.8 *	8.8 ↘	10.1 ↗
10.1 ←	10.3 *	9.6 ↙	9.9 ↗	9.1 →

**beste Teiler:** 50.4 (23.), 137.4 (21.), 153.3 (27.)  
**Trefferlage:** 0.13 mm links, 0.16 mm hoch  
**Streuwert:** 2.33, horizontal: 2.29, vertikal: 2.37

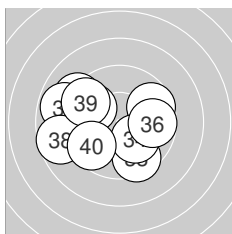

**Serie 4:**

9.1 ↘	9.7 ↗	9.5 ↓	10.1 ↘	8.8 ↖
9.7 →	9.8 ↖	8.7 ←	9.5 ↘	9.6 ↙

**beste Teiler:** 210.1 (34.), 281.7 (37.), 304.1 (36.)  
**Trefferlage:** 1.36 mm links, 0.04 mm tief  
**Streuwert:** 2.70, horizontal: 3.28, vertikal: 1.96



Ergebnis: **396.5** (377)  
 Serien: 96.6 101.3 101.1 97.5  
 Zähler: 18 21 1 0 0 0 0 0 0  
 Innenzehner: 12  
 Weitestе: 580 (39.), 493 (2.), 476 (6.)  
 beste Teiler: 10.7 (12.), 45.1 (35.), 46.0 (19.)  
 Trefferlage: 0.00 mm , 0.62 mm hoch  
 Streuwert: 2.04, horizontal: 2.20, vertikal: 1.87

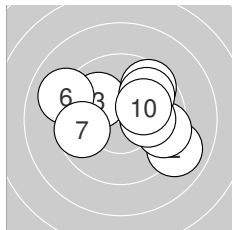
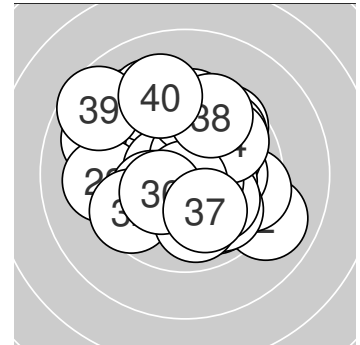

**Serie 1:**

9.8 ↘	9.0 ↘	10.0 ↘	9.6 ↗	9.5 →
9.0 ↘	9.7 ←	9.8 ↗	10.1 →	10.1 ↗

beste Teiler: 209.4 (10.), 218.0 (9.), 233.3 (3.)  
 Trefferlage: 0.43 mm rechts, 0.60 mm hoch  
 Streuwert: 2.43, horizontal: 3.06, vertikal: 1.56

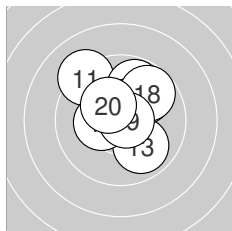

**Serie 2:**

9.2 ↘	10.9 *	9.9 ↘	9.9 ↗	9.8 ↗
10.5 *	10.3 *	9.7 ↗	10.8 *	10.3 *

beste Teiler: 10.7 (12.), 46.0 (19.), 120.3 (16.)  
 Trefferlage: 0.22 mm rechts, 1.02 mm hoch  
 Streuwert: 1.60, horizontal: 1.60, vertikal: 1.60

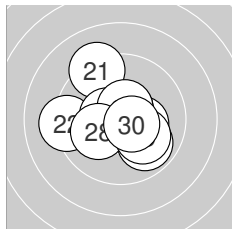

**Serie 3:**

9.2 ↘	9.2 ←	10.3 *	10.6 *	10.5 *
10.6 *	9.9 ↘	10.1 ←	10.1 ↘	10.6 *

beste Teiler: 90.3 (24.), 97.1 (30.), 98.4 (26.)  
 Trefferlage: 0.21 mm links, 0.05 mm hoch  
 Streuwert: 1.83, horizontal: 2.02, vertikal: 1.62

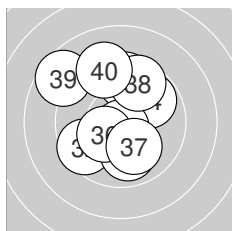

**Serie 4:**

9.6 ↑	9.6 ↗	9.9 ↓	9.8 ↗	10.8 *
10.3 *	10.1 ↘	9.6 ↗	8.6 ↘	9.2 ↗

beste Teiler: 45.1 (35.), 159.8 (36.), 222.9 (37.)  
 Trefferlage: 0.43 mm links, 0.81 mm hoch  
 Streuwert: 2.38, horizontal: 2.10, vertikal: 2.64





Ergebnis: **395.4** (379)  
 Serien: 95.5 100.2 100.1 99.6  
 Zähler: 23 13 4 0 0 0 0 0 0  
 Innenzehner: 18  
 Weitester: 635 (1.), 621 (7.), 567 (38.)  
 beste Teiler: 33.9 (13.), 104.0 (28.), 110.3 (19.)  
 Trefferlage: 0.13 mm rechts, 0.02 mm tief  
 Streuwert: 2.18, horizontal: 2.55, vertikal: 1.73

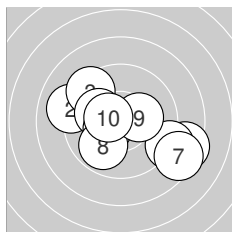
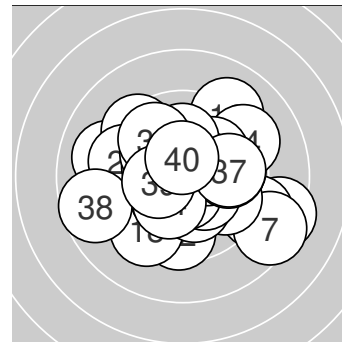

**Serie 1:**

8.4 ↘	9.1 ←	9.4 ↘	10.1 ↖	10.4 *
8.9 ↘	8.5 ↘	9.9 ↗	10.3 *	10.5 *

beste Teiler: 118.0 (10.), 137.4 (5.), 172.7 (9.)  
 Trefferlage: 0.42 mm rechts, 0.51 mm tief  
 Streuwert: 2.94, horizontal: 3.69, vertikal: 1.91

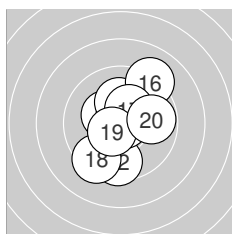

**Serie 2:**

10.3 *	9.6 ↓	10.8 *	10.2 *	10.2 *
9.1 ↗	10.3 *	9.4 ↗	10.5 *	9.8 →

beste Teiler: 33.9 (13.), 110.3 (19.), 151.6 (17.)  
 Trefferlage: 0.35 mm rechts, 0.14 mm hoch  
 Streuwert: 1.97, horizontal: 1.68, vertikal: 2.23

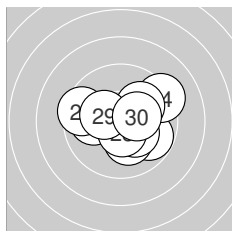

**Serie 3:**

9.8 ↘	10.2 *	10.3 *	9.2 ↗	10.0 ←
10.0 ↗	9.5 ←	10.5 *	10.3 *	10.3 *

beste Teiler: 104.0 (28.), 156.3 (30.), 161.7 (29.)  
 Trefferlage: 0.42 mm rechts, 0.02 mm hoch  
 Streuwert: 1.86, horizontal: 2.29, vertikal: 1.29

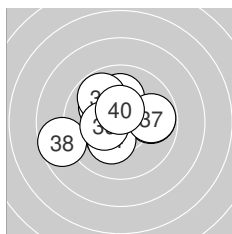

**Serie 4:**

10.1 ↘	10.3 *	9.8 →	10.2 *	10.1 ↑
9.8 ↘	9.8 →	8.7 ←	10.3 *	10.5 *

beste Teiler: 113.2 (40.), 152.6 (39.), 161.6 (32.)  
 Trefferlage: 0.65 mm links, 0.26 mm hoch  
 Streuwert: 1.97, horizontal: 2.35, vertikal: 1.50



Ergebnis: **395.4** (376)  
 Serien: 97.6 98.2 99.7 99.9  
 Zähler: 18 20 2 0 0 0 0 0 0 0  
 Innenzehner: 14  
 Weitesten: 626 (7.), 525 (1.), 476 (29.)  
 beste Teiler: 61.3 (33.), 76.2 (19.), 81.1 (24.)  
 Trefferlage: 0.45 mm links, 1.20 mm hoch  
 Streuwert: 1.91, horizontal: 2.33, vertikal: 1.38

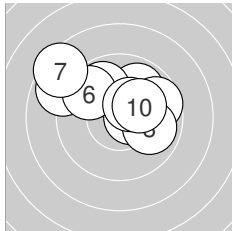
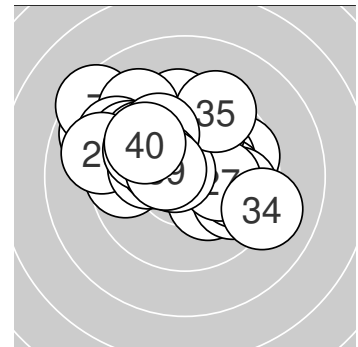

**Serie 1:**

8.9 ↙	9.9 ↗	9.9 ↘	10.6 *	9.7 →
9.7 ↙	8.4 ↙	9.9 →	10.4 *	10.2 *

beste Teiler: 93.0 (4.), 135.8 (9.), 188.6 (10.)  
 Trefferlage: 0.32 mm links, 1.51 mm hoch  
 Streuwert: 2.25, horizontal: 2.88, vertikal: 1.35

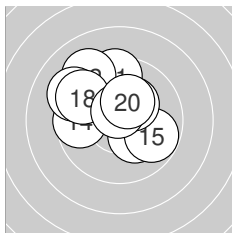

**Serie 2:**

9.5 ↑	9.2 ↘	10.2 *	9.6 ←	9.8 →
9.2 ↙	10.3 *	9.5 ↙	10.6 *	10.3 *

beste Teiler: 76.2 (19.), 167.5 (20.), 169.6 (17.)  
 Trefferlage: 0.75 mm links, 1.24 mm hoch  
 Streuwert: 2.02, horizontal: 2.25, vertikal: 1.76

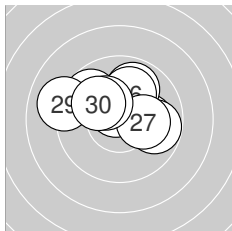

**Serie 3:**

10.1 →	9.7 ↘	9.8 →	10.6 *	9.9 ↗
10.1 ↗	10.2 *	10.2 *	9.0 ←	10.1 ↘

beste Teiler: 81.1 (24.), 176.5 (28.), 197.3 (27.)  
 Trefferlage: 0.12 mm links, 1.01 mm hoch  
 Streuwert: 1.82, horizontal: 2.35, vertikal: 1.05

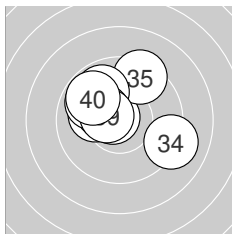

**Serie 4:**

10.1 ←	10.2 *	10.7 *	9.1 →	9.4 ↗
9.9 ↘	10.3 *	9.9 ↘	10.5 *	9.8 ↘

beste Teiler: 61.3 (33.), 112.2 (39.), 155.6 (37.)  
 Trefferlage: 0.62 mm links, 1.04 mm hoch  
 Streuwert: 1.78, horizontal: 2.06, vertikal: 1.44



Ergebnis: **368.1** (349)  
 Serien: 90.4 92.6 93.7 91.4  
 Zähler: 8 22 3 5 2 0 0 0 0 0  
 Innenzehner: 6  
 Weitester: 1095 (4.), 1084 (8.), 961 (35.)  
 beste Teiler: 91.1 (6.), 112.7 (12.), 157.4 (25.)  
 Trefferlage: 0.43 mm links, 0.10 mm hoch  
 Streuwert: 3.63, horizontal: 4.38, vertikal: 2.67

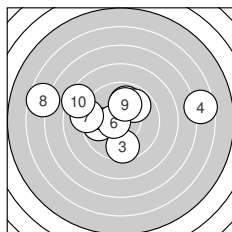
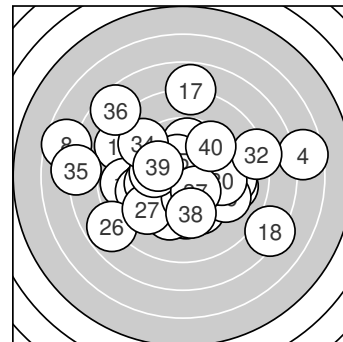

**Serie 1:**  
 9.9 ↑                      9.8 ←                      9.6 ↓                      6.6 →                      9.8 ↗  
 10.6 \*                      9.1 ←                      6.6 ↖                      10.0 ↑                      8.4 ↙  
 beste Teiler: 91.1 (6.), 234.7 (9.), 260.1 (1.)  
 Trefferlage: 1.03 mm links, 1.12 mm hoch  
 Streuwert: 4.19, horizontal: 5.60, vertikal: 1.96

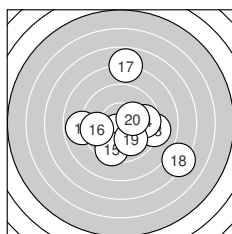

**Serie 2:**  
 8.9 ←                      10.5 \*                      9.1 →                      9.7 →                      9.5 ↓  
 9.6 ←                      7.8 ↑                      7.3 ↘                      9.9 ↘                      10.3 \*  
 beste Teiler: 112.7 (12.), 173.6 (20.), 252.9 (19.)  
 Trefferlage: 0.91 mm rechts, 0.52 mm tief  
 Streuwert: 3.57, horizontal: 3.76, vertikal: 3.37

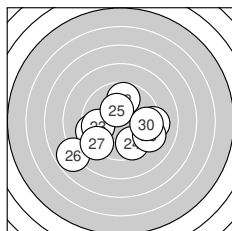

**Serie 3:**  
 9.3 ←                      9.8 ↑                      9.7 ←                      9.6 ↓                      10.3 \*  
 7.8 ↙                      9.2 ↘                      9.2 →                      9.2 ↘                      9.6 →  
 beste Teiler: 157.4 (25.), 299.2 (22.), 309.8 (23.)  
 Trefferlage: 0.33 mm links, 1.05 mm tief  
 Streuwert: 3.04, horizontal: 3.69, vertikal: 2.21

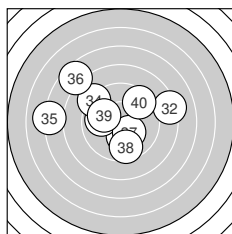

**Serie 4:**  
 10.2 \*                      8.2 →                      9.9 ←                      9.1 ↘                      7.1 ←  
 7.6 ↘                      10.2 \*                      9.6 ↓                      10.0 ↖                      9.5 ↗  
 beste Teiler: 177.3 (37.), 191.5 (31.), 240.4 (39.)  
 Trefferlage: 1.27 mm links, 0.87 mm hoch  
 Streuwert: 3.76, horizontal: 4.58, vertikal: 2.69



**Ergebnis:** **389.6** (372)  
**Serien:** 95.4 96.7 98.3 99.2  
**Zähler:** 15 24 0 0 1 0 0 0 0 0  
**Innenzehner:** 13  
**Weiteste:** 1054 (8.), 495 (27.), 493 (17.)  
**beste Teiler:** 112.4 (22.), 120.0 (33.), 135.5 (30.)  
**Trefferlage:** 0.03 mm rechts, 0.30 mm hoch  
**Streuwert:** 2.46, horizontal: 2.89, vertikal: 1.92

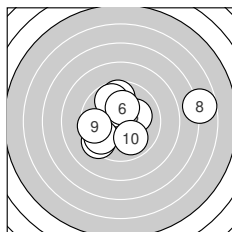
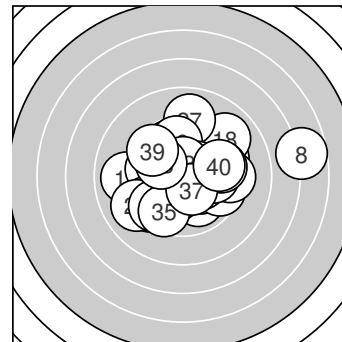

**Serie 1:**  
 9.4 ↙                      9.7 ↑                      10.3 \*                      9.8 ↘                      10.2 \*  
 10.2 \*                      9.6 ↙                      6.7 →                      9.6 ←                      9.9 ↘  
**beste Teiler:** 164.3 (3.), 179.4 (6.), 200.2 (5.)  
**Trefferlage:** 0.27 mm rechts, 0.43 mm hoch  
**Streuwert:** 3.18, horizontal: 3.95, vertikal: 2.14

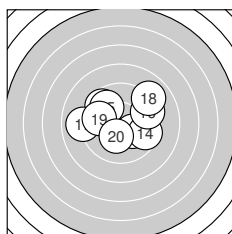

**Serie 2:**  
 10.2 \*                      10.0 ←                      9.6 ↘                      9.6 →                      9.9 ↘  
 9.4 →                      9.0 ←                      9.0 ↗                      9.8 ←                      10.2 \*  
**beste Teiler:** 178.3 (20.), 188.6 (11.), 233.5 (12.)  
**Trefferlage:** 0.28 mm links, 0.61 mm hoch  
**Streuwert:** 2.47, horizontal: 3.07, vertikal: 1.66

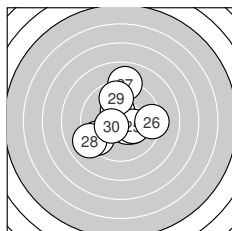

**Serie 3:**  
 10.3 \*                      10.5 \*                      10.4 \*                      9.4 ↙                      10.3 \*  
 9.3 →                      9.0 ↑                      9.0 ↙                      9.7 ↑                      10.4 \*  
**beste Teiler:** 112.4 (22.), 135.5 (30.), 140.1 (23.)  
**Trefferlage:** 0.08 mm links, 0.15 mm hoch  
**Streuwert:** 2.34, horizontal: 2.36, vertikal: 2.32

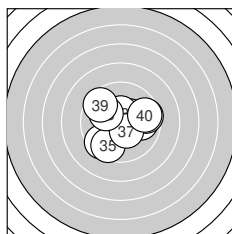

**Serie 4:**  
 9.9 →                      10.4 \*                      10.5 \*                      9.5 ↙                      9.6 ↙  
 9.6 →                      10.4 \*                      10.1 ↘                      9.6 ↘                      9.6 →  
**beste Teiler:** 120.0 (33.), 139.2 (37.), 147.5 (32.)  
**Trefferlage:** 0.24 mm rechts, 0.01 mm hoch  
**Streuwert:** 2.06, horizontal: 2.34, vertikal: 1.74



Ergebnis: **373.3** (355)  
 Serien: 94.2 97.0 88.3 93.8  
 Zähler: 12 14 11 3 0 0 0 0 0 0  
 Innenzehner: 7  
 Weitester: 999 (10.), 810 (28.), 772 (6.)  
 beste Teiler: 90.1 (12.), 105.6 (16.), 116.1 (7.)  
 Trefferlage: 0.68 mm rechts, 1.02 mm tief  
 Streuwert: 3.18, horizontal: 3.98, vertikal: 2.10

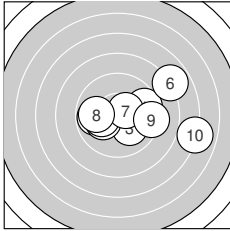
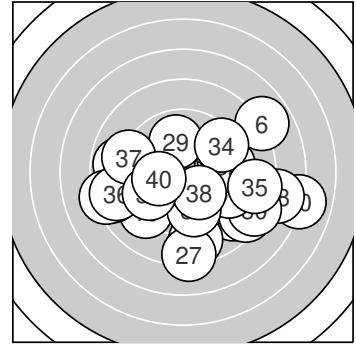

**Serie 1:**

9.5 →	9.8 ←	10.1 ↘	10.2 *	10.1 ←
7.9 ↗	10.5 *	9.9 ←	9.2 →	7.0 →

beste Teiler: 116.1 (7.), 198.7 (4.), 203.5 (5.)  
 Trefferlage: 1.70 mm rechts, 0.01 mm tief  
 Streuwert: 3.25, horizontal: 4.25, vertikal: 1.75

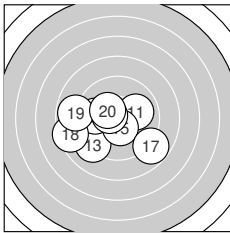

**Serie 2:**

10.0 →	10.6 *	9.2 ↙	9.8 ←	10.5 *
10.5 *	8.8 ↘	8.5 ←	8.8 ←	10.3 *

beste Teiler: 90.1 (12.), 105.6 (16.), 123.7 (15.)  
 Trefferlage: 1.31 mm links, 0.76 mm tief  
 Streuwert: 2.51, horizontal: 3.13, vertikal: 1.67

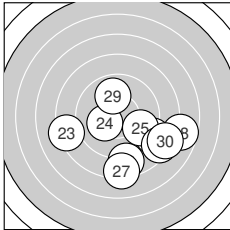

**Serie 3:**

8.9 ↘	8.7 ↓	8.3 ←	10.2 *	9.7 ↘
8.4 ↘	8.2 ↓	7.7 →	9.9 ↑	8.3 ↘

beste Teiler: 181.1 (24.), 258.8 (29.), 321.1 (25.)  
 Trefferlage: 1.92 mm rechts, 2.55 mm tief  
 Streuwert: 3.49, horizontal: 4.22, vertikal: 2.57

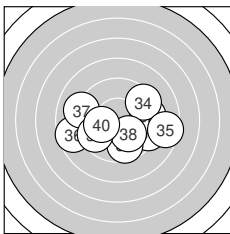

**Serie 4:**

9.3 ↘	9.4 →	9.7 ↓	9.4 ↗	8.5 →
8.6 ←	9.1 ←	10.1 ↘	9.6 ↙	10.1 ←

beste Teiler: 208.1 (40.), 217.0 (38.), 325.9 (33.)  
 Trefferlage: 0.42 mm rechts, 0.76 mm tief  
 Streuwert: 3.01, horizontal: 3.93, vertikal: 1.64



Ergebnis: **356.1** (339)  
 Serien: 88.5 89.5 90.7 87.4  
 Zähler: 5 16 14 3 2 0 0 0 0 0  
 Innenzehner: 4  
 Weitester: 1211 (25.), 1083 (2.), 973 (34.)  
 beste Teiler: 121.1 (28.), 147.1 (23.), 174.6 (16.)  
 Trefferlage: 0.81 mm rechts, 1.78 mm tief  
 Streuwert: 3.81, horizontal: 4.23, vertikal: 3.34

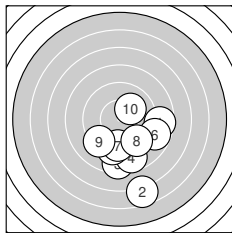
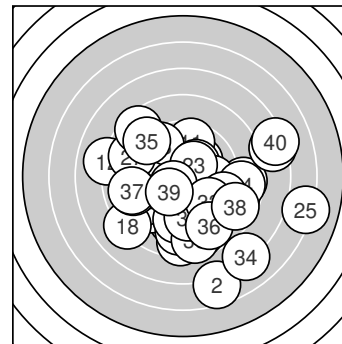

**Serie 1:**

8.6 →	6.6 ↓	8.4 ↓	8.7 ↓	9.2 ↓
8.8 →	9.5 ↓	9.4 ↘	9.2 ↗	10.1 ↗

beste Teiler: 212.8 (10.), 375.9 (7.), 391.3 (8.)  
 Trefferlage: 1.52 mm rechts, 3.73 mm tief  
 Streuwert: 2.99, horizontal: 2.72, vertikal: 3.24

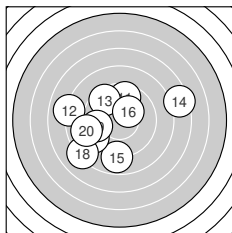

**Serie 2:**

9.6 ↑	8.0 ←	9.5 ↘	7.4 →	8.8 ↓
10.3 *	9.2 ↗	8.1 ↗	9.6 ←	9.0 ←

beste Teiler: 174.6 (16.), 334.7 (11.), 335.4 (19.)  
 Trefferlage: 1.62 mm links, 0.32 mm tief  
 Streuwert: 3.85, horizontal: 4.47, vertikal: 3.11

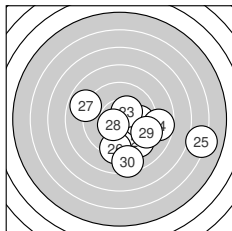

**Serie 3:**

9.3 ↘	9.8 →	10.4 *	8.7 →	6.1 →
9.3 ↓	8.9 ←	10.5 *	9.2 ↘	8.5 ↓

beste Teiler: 121.1 (28.), 147.1 (23.), 280.4 (22.)  
 Trefferlage: 2.23 mm rechts, 1.73 mm tief  
 Streuwert: 3.55, horizontal: 4.40, vertikal: 2.44

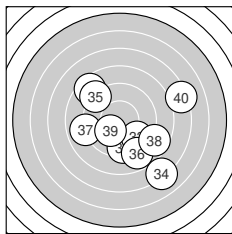

**Serie 4:**

9.4 ↓	8.5 ↘	9.6 ↘	7.1 ↘	9.0 ↘
8.8 ↘	8.9 ←	8.7 ↘	10.2 *	7.2 →

beste Teiler: 198.4 (39.), 343.7 (33.), 393.8 (31.)  
 Trefferlage: 1.13 mm rechts, 1.33 mm tief  
 Streuwert: 4.29, horizontal: 4.63, vertikal: 3.92



Ergebnis: **378.5** (362)  
 Serien: 95.9 94.3 93.6 94.7  
 Zähler: 11 21 7 1 0 0 0 0 0 0  
 Innenzehner: 10  
 Weitestе: 871 (4.), 733 (23.), 714 (32.)  
 beste Teiler: 10.2 (10.), 74.4 (25.), 123.2 (1.)  
 Trefferlage: 0.02 mm rechts, 0.72 mm tief  
 Streuwert: 2.95, horizontal: 3.30, vertikal: 2.57

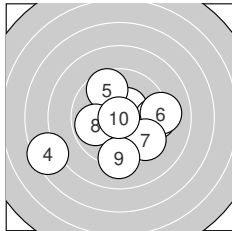
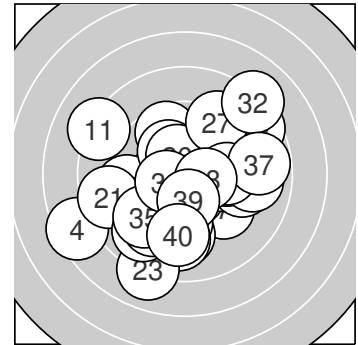

**Serie 1:**

10.5 *	10.2 *	9.4 →	7.5 ←	9.6 ↖
9.2 →	9.5 ↘	9.9 ←	9.2 ↓	10.9 *

beste Teiler: 10.2 (10.), 123.2 (1.), 179.7 (2.)  
 Trefferlage: 0.17 mm links, 0.78 mm tief  
 Streuwert: 2.98, horizontal: 3.57, vertikal: 2.25

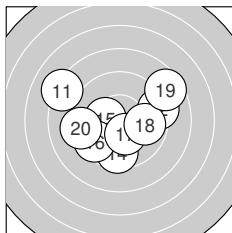

**Serie 2:**

8.1 ↖	9.2 →	9.7 ←	9.6 ↓	10.3 *
9.5 ↙	10.3 *	9.8 →	8.6 ↗	9.2 ←

beste Teiler: 155.4 (15.), 163.6 (17.), 276.5 (18.)  
 Trefferlage: 0.53 mm links, 0.16 mm tief  
 Streuwert: 3.04, horizontal: 3.68, vertikal: 2.22

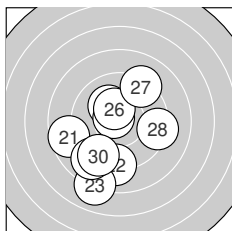

**Serie 3:**

8.7 ←	9.1 ↓	8.0 ↓	10.1 ↖	10.7 *
10.4 *	9.2 ↗	9.3 →	8.9 ↙	9.2 ↙

beste Teiler: 74.4 (25.), 144.6 (26.), 203.6 (24.)  
 Trefferlage: 0.98 mm links, 1.46 mm tief  
 Streuwert: 3.04, horizontal: 2.72, vertikal: 3.33

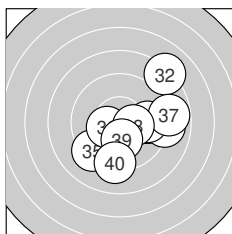

**Serie 4:**

9.7 →	8.1 ↗	9.0 →	9.7 →	9.3 ↙
10.4 *	8.8 →	10.3 *	10.2 *	9.2 ↓

beste Teiler: 145.3 (36.), 153.5 (38.), 191.5 (39.)  
 Trefferlage: 1.80 mm rechts, 0.48 mm tief  
 Streuwert: 2.72, horizontal: 2.88, vertikal: 2.54



Ergebnis: **399.2** (380)  
 Serien: 99.1 100.7 98.9 100.5  
 Zähler: 23 15 1 1 0 0 0 0 0 0  
 Innenzehner: 17  
 Weitester: 756 (1.), 643 (39.), 392 (33.)  
 beste Teiler: 34.7 (38.), 58.6 (17.), 76.9 (12.)  
 Trefferlage: 0.14 mm links, 0.80 mm hoch  
 Streuwert: 1.91, horizontal: 1.78, vertikal: 2.03

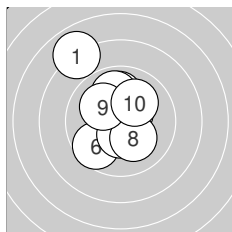
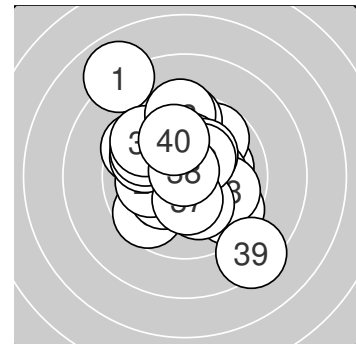

**Serie 1:**

7.9 ↘	9.9 ↑	10.5 *	10.5 *	9.9 ↑
9.6 ↗	10.4 *	10.2 *	10.1 ↘	10.1 ↗

beste Teiler: 114.7 (3.), 121.1 (4.), 126.0 (7.)  
 Trefferlage: 0.51 mm links, 0.89 mm hoch  
 Streuwert: 2.22, horizontal: 1.75, vertikal: 2.60

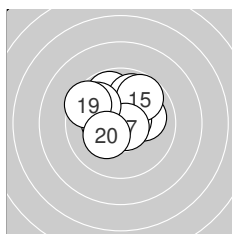

**Serie 2:**

10.1 →	10.6 *	9.8 ↘	9.9 ↗	9.7 ↗
10.3 *	10.7 *	9.8 ↘	9.5 ↘	10.3 *

beste Teiler: 58.6 (17.), 76.9 (12.), 151.2 (16.)  
 Trefferlage: 0.30 mm links, 1.04 mm hoch  
 Streuwert: 1.57, horizontal: 1.78, vertikal: 1.32

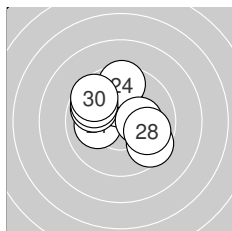

**Serie 3:**

10.1 ←	10.1 ↘	10.3 *	9.5 ↑	9.5 ↘
9.8 ↘	10.3 *	9.9 ↘	9.8 ↘	9.6 ↘

beste Teiler: 168.2 (23.), 174.0 (27.), 220.9 (21.)  
 Trefferlage: 0.40 mm links, 0.86 mm hoch  
 Streuwert: 1.93, horizontal: 2.14, vertikal: 1.68

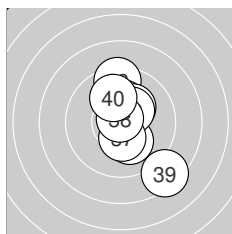

**Serie 4:**

10.2 *	10.5 *	9.4 ↑	10.2 *	10.2 *
10.4 *	10.4 *	10.8 *	8.4 ↘	10.0 ↑

beste Teiler: 34.7 (38.), 125.1 (32.), 148.0 (36.)  
 Trefferlage: 0.64 mm rechts, 0.39 mm hoch  
 Streuwert: 2.02, horizontal: 1.38, vertikal: 2.50





Ergebnis: **369.1** (352)  
 Serien: 90.0 92.2 96.5 90.4  
 Zähler: 9 17 13 0 0 1 0 0 0 0  
 Innenzehner: 7  
 Weitester: 1302 (3.), 747 (7.), 698 (39.)  
 beste Teiler: 85.4 (13.), 93.0 (25.), 120.3 (2.)  
 Trefferlage: 0.24 mm links, 0.37 mm hoch  
 Streuwert: 3.49, horizontal: 3.98, vertikal: 2.92

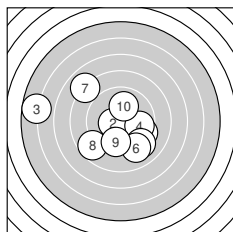
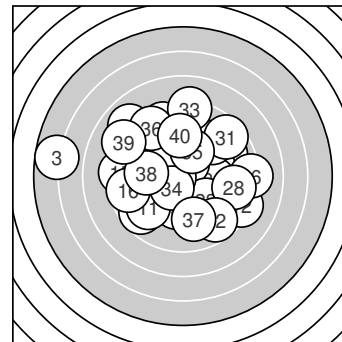

**Serie 1:**  
 9.4 → 10.5 \* 5.7 ← 9.8 → 9.1 ↘  
 9.1 ↘ 8.0 ↘ 8.7 ↗ 9.7 ↓ 10.0 ↑  
 beste Teiler: 120.3 (2.), 233.9 (10.), 297.3 (4.)  
 Trefferlage: 1.22 mm links, 0.76 mm tief  
 Streuwert: 4.22, horizontal: 5.12, vertikal: 3.06

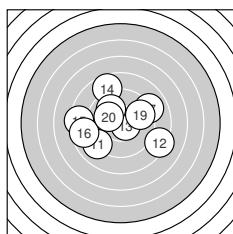

**Serie 2:**  
 9.0 ↙ 8.3 → 10.6 \* 8.7 ↗ 8.4 ←  
 8.6 ← 9.0 → 9.9 ↘ 9.6 → 10.1 ↘  
 beste Teiler: 85.4 (13.), 208.0 (20.), 259.1 (18.)  
 Trefferlage: 0.68 mm links, 0.44 mm hoch  
 Streuwert: 3.45, horizontal: 4.13, vertikal: 2.59

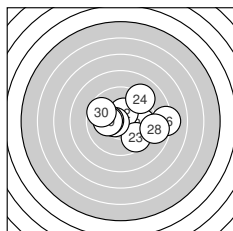

**Serie 3:**  
 9.7 → 10.4 \* 9.6 ↘ 9.1 ↗ 10.6 \*  
 8.2 → 10.2 \* 8.8 → 10.2 \* 9.7 ↘  
 beste Teiler: 93.0 (25.), 136.6 (22.), 178.3 (27.)  
 Trefferlage: 1.34 mm rechts, 0.21 mm hoch  
 Streuwert: 2.59, horizontal: 3.30, vertikal: 1.57

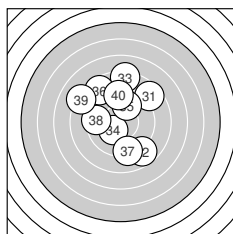

**Serie 4:**  
 8.6 ↗ 8.7 ↘ 8.2 ↑ 10.3 \* 9.9 ↗  
 8.6 ↘ 9.1 ↓ 9.5 ← 8.2 ↘ 9.3 ↑  
 beste Teiler: 166.2 (34.), 269.8 (35.), 375.4 (38.)  
 Trefferlage: 0.40 mm links, 1.61 mm hoch  
 Streuwert: 3.59, horizontal: 3.23, vertikal: 3.91



Ergebnis: **340.6** (323)  
 Serien: 79.3 91.7 85.4 84.2  
 Zähler: 7 12 10 7 1 2 0 0 0 0  
 Innenzehner: 4  
 Weitester: 2553 (4.), 1340 (2.), 1321 (31.)  
 beste Teiler: 71.8 (15.), 132.2 (3.), 188.6 (22.)  
 Trefferlage: 2.73 mm links, 0.10 mm hoch  
 Streuwert: 4.99, horizontal: 6.13, vertikal: 3.48

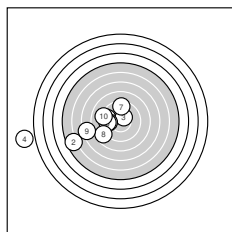
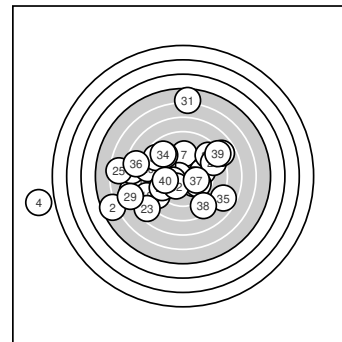

**Serie 1:**  
 9.5 ←                      5.6 ←                      10.4 \*                      0.0 ←                      9.7 ←  
 9.6 ←                      9.4 ↑                      8.7 ↙                      7.3 ←                      9.1 ←  
 beste Teiler: 132.2 (3.), 308.2 (5.), 343.6 (6.)  
 Trefferlage: 6.41 mm links, 0.95 mm tief  
 Streuwert: 5.78, horizontal: 7.62, vertikal: 2.95

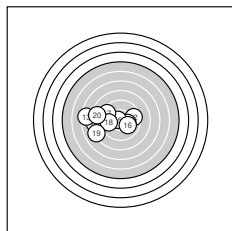

**Serie 2:**  
 8.2 ←                      9.6 →                      7.4 ←                      10.2 \*                      10.7 \*  
 10.0 ↘                      9.4 ↖                      9.7 ←                      8.1 ↙                      8.4 ←  
 beste Teiler: 71.8 (15.), 192.2 (14.), 226.3 (16.)  
 Trefferlage: 2.84 mm links, 0.17 mm tief  
 Streuwert: 3.20, horizontal: 4.26, vertikal: 1.53

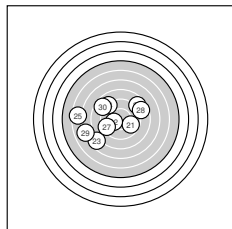

**Serie 3:**  
 9.8 ↘                      10.2 \*                      7.6 ↙                      9.0 ↘                      6.5 ←  
 8.7 ↗                      9.3 ←                      8.6 ↗                      7.0 ←                      8.7 ↘  
 beste Teiler: 188.6 (22.), 298.3 (21.), 413.5 (27.)  
 Trefferlage: 2.74 mm links, 0.06 mm hoch  
 Streuwert: 4.52, horizontal: 5.52, vertikal: 3.23

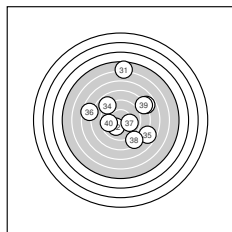

**Serie 4:**  
 5.7 ↑                      10.1 ↙                      7.8 ↗                      8.9 ↘                      7.8 ↘  
 7.6 ←                      10.0 →                      8.5 ↘                      8.1 ↗                      9.7 ←  
 beste Teiler: 209.7 (32.), 243.9 (37.), 316.3 (40.)  
 Trefferlage: 1.06 mm rechts, 1.50 mm hoch  
 Streuwert: 5.14, horizontal: 5.03, vertikal: 5.24



Ergebnis: **353.9** (334)  
 Serien: 94.8 80.4 86.6 92.1  
 Zähler: 8 10 11 10 1 0 0 0 0 0  
 Innenzehner: 5  
 Weitester: 1215 (20.), 990 (22.), 974 (11.)  
 beste Teiler: 49.5 (40.), 77.3 (17.), 82.0 (9.)  
 Trefferlage: 0.49 mm links, 0.02 mm tief  
 Streuwert: 4.26, horizontal: 4.73, vertikal: 3.75

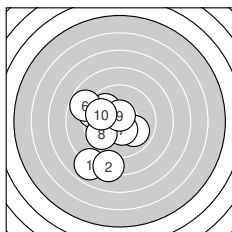
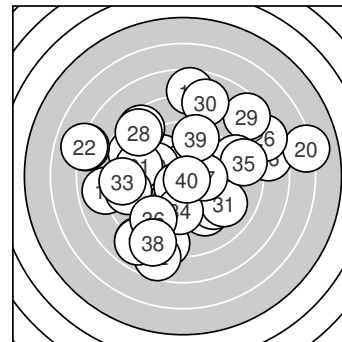

**Serie 1:**  
 7.9 ↙ 8.3 ↓ 9.4 ↖ 9.9 ↗ 10.0 ↘  
 8.8 ↖ 10.4 \* 9.7 ↗ 10.6 \* 9.8 ↖  
 beste Teiler: 82.0 (9.), 126.2 (7.), 248.5 (5.)  
 Trefferlage: 1.95 mm links, 0.99 mm tief  
 Streuwert: 2.71, horizontal: 2.22, vertikal: 3.13

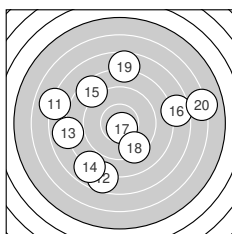

**Serie 2:**  
 7.1 ↖ 7.7 ↓ 7.9 ← 7.9 ↗ 8.5 ↘  
 7.6 → 10.6 \* 9.3 ↘ 7.7 ↑ 6.1 →  
 beste Teiler: 77.3 (17.), 408.3 (18.), 608.6 (15.)  
 Trefferlage: 0.44 mm links, 0.03 mm hoch  
 Streuwert: 5.85, horizontal: 6.62, vertikal: 4.95

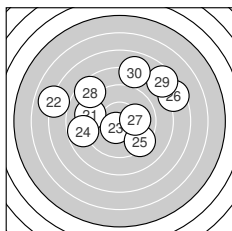

**Serie 3:**  
 9.2 ↖ 7.0 ↖ 10.5 \* 8.8 ← 9.3 ↘  
 7.5 → 10.1 → 8.6 ↘ 7.6 ↗ 8.0 ↑  
 beste Teiler: 111.0 (23.), 225.0 (27.), 408.7 (25.)  
 Trefferlage: 0.25 mm links, 1.94 mm hoch  
 Streuwert: 4.51, horizontal: 5.47, vertikal: 3.27

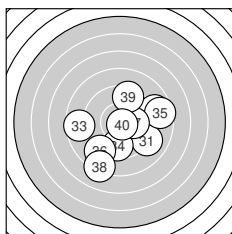

**Serie 4:**  
 9.1 ↘ 8.8 → 8.6 ← 9.6 ↓ 8.6 →  
 8.9 ↗ 10.1 → 8.2 ↓ 9.4 ↑ 10.8 \*  
 beste Teiler: 49.5 (40.), 203.3 (37.), 336.4 (34.)  
 Trefferlage: 0.65 mm rechts, 1.07 mm tief  
 Streuwert: 3.41, horizontal: 3.76, vertikal: 3.03



**Ergebnis:** **411.8** (393)  
**Serien:** 103.1 103.9 101.6 103.2  
**Zähler:** 33 7 0 0 0 0 0 0 0  
**Innenzehner:** 27  
**Weiteste:** 317 (3.), 303 (22.), 293 (4.)  
**beste Teiler:** 6.3 (37.), 23.3 (8.), 32.6 (7.)  
**Trefferlage:** 0.09 mm links, 0.07 mm hoch  
**Streuwert:** 1.31, horizontal: 1.45, vertikal: 1.15

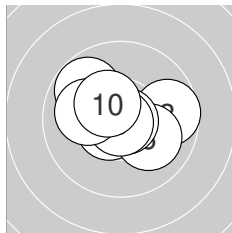
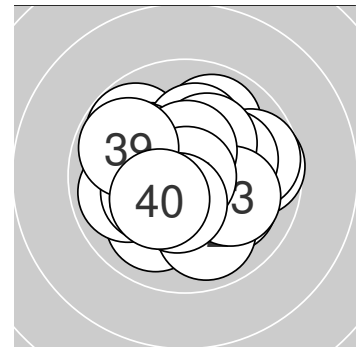

**Serie 1:**  
 10.5 \*                      10.2 \*                      9.7 →                      9.8 ↘                      10.6 \*  
 10.1 ↘                      10.8 \*                      10.9 \*                      10.1 ←                      10.4 \*  
**beste Teiler:** 23.3 (8.), 32.6 (7.), 91.5 (5.)  
**Trefferlage:** 0.00 mm , 0.20 mm hoch  
**Streuwert:** 1.41, horizontal: 1.78, vertikal: 0.91

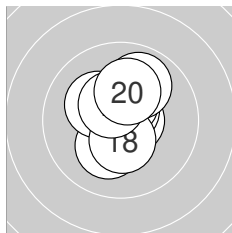

**Serie 2:**  
 10.7 \*                      10.6 \*                      10.7 \*                      10.5 \*                      10.2 \*  
 10.2 \*                      9.9 ↗                      10.4 \*                      10.5 \*                      10.2 \*  
**beste Teiler:** 71.0 (11.), 75.6 (13.), 87.1 (12.)  
**Trefferlage:** 0.02 mm links, 0.58 mm hoch  
**Streuwert:** 1.08, horizontal: 0.82, vertikal: 1.29

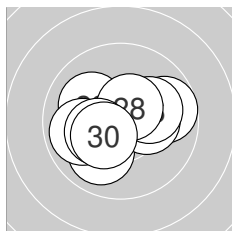

**Serie 3:**  
 10.4 \*                      9.7 →                      10.1 ↘                      10.0 ✓                      10.2 \*  
 10.1 →                      9.9 ←                      10.5 \*                      10.3 \*                      10.4 \*  
**beste Teiler:** 112.0 (28.), 138.4 (21.), 148.2 (30.)  
**Trefferlage:** 0.24 mm links, 0.15 mm tief  
**Streuwert:** 1.53, horizontal: 1.90, vertikal: 1.03

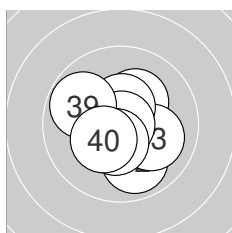

**Serie 4:**  
 10.2 \*                      9.9 ↓                      10.1 ↘                      10.5 \*                      10.5 \*  
 10.5 \*                      10.9 \*                      10.5 \*                      9.8 ↘                      10.3 \*  
**beste Teiler:** 6.3 (37.), 105.3 (36.), 111.2 (35.)  
**Trefferlage:** 0.13 mm links, 0.32 mm tief  
**Streuwert:** 1.28, horizontal: 1.28, vertikal: 1.27



Ergebnis: **399.7** (383)  
 Serien: 100.4 100.7 99.3 99.3  
 Zähler: 24 15 1 0 0 0 0 0 0 0  
 Innenzehner: 15  
 Weitestе: 508 (27.), 416 (6.), 415 (34.)  
 beste Teiler: 21.8 (26.), 65.2 (7.), 78.7 (16.)  
 Trefferlage: 0.19 mm links, 0.43 mm hoch  
 Streuwert: 1.84, horizontal: 2.17, vertikal: 1.43

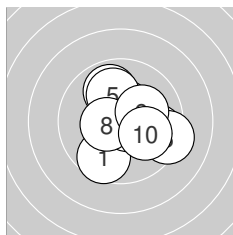
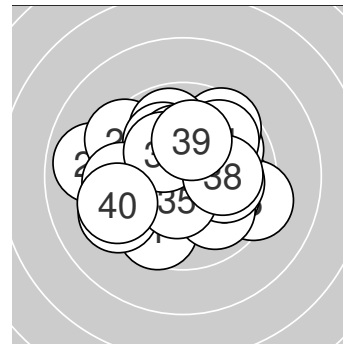

**Serie 1:**  
 9.6 ↙                      9.7 →                      10.5 \*                      9.9 ↑                      10.0 ↑  
 9.3 →                      10.7 \*                      10.5 \*                      10.2 \*                      10.0 →  
 beste Teiler: 65.2 (7.), 118.8 (8.), 124.9 (3.)  
 Trefferlage: 0.76 mm rechts, 0.00 mm  
 Streuwert: 1.78, horizontal: 1.86, vertikal: 1.70

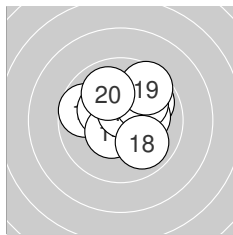

**Serie 2:**  
 9.9 ↗                      9.7 ←                      10.3 \*                      10.5 \*                      10.2 \*  
 10.6 \*                      10.0 ↗                      9.9 ↘                      9.6 ↗                      10.0 ↓  
 beste Teiler: 78.7 (16.), 121.6 (14.), 165.1 (13.)  
 Trefferlage: 0.39 mm rechts, 0.77 mm hoch  
 Streuwert: 1.63, horizontal: 1.85, vertikal: 1.37

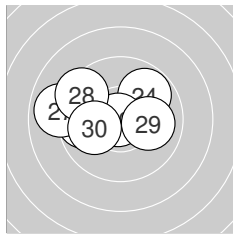

**Serie 3:**  
 9.7 ←                      10.2 \*                      10.2 \*                      9.8 ↗                      10.2 \*  
 10.9 \*                      8.9 ←                      9.4 ↘                      10.0 →                      10.0 ←  
 beste Teiler: 21.8 (26.), 180.0 (25.), 187.8 (23.)  
 Trefferlage: 0.78 mm links, 0.49 mm hoch  
 Streuwert: 1.98, horizontal: 2.63, vertikal: 0.98

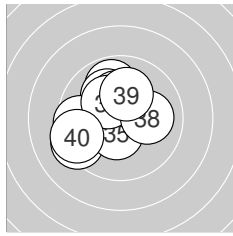

**Serie 4:**  
 9.8 ↑                      10.1 ↓                      9.6 ←                      9.3 ←                      10.4 \*  
 10.2 \*                      10.3 \*                      10.1 →                      10.1 ↑                      9.4 ←  
 beste Teiler: 129.2 (35.), 172.8 (37.), 177.6 (36.)  
 Trefferlage: 1.16 mm links, 0.45 mm hoch  
 Streuwert: 1.81, horizontal: 1.92, vertikal: 1.69



Ergebnis: **410.6** (391)  
 Serien: 102.7 102.5 101.8 103.6  
 Zähler: 31 9 0 0 0 0 0 0 0 0  
 Innenzehner: 28  
 Weitesten: 338 (3.), 338 (18.), 317 (23.)  
 beste Teiler: 54.8 (24.), 57.0 (27.), 66.7 (31.)  
 Trefferlage: 0.29 mm links, 0.78 mm hoch  
 Streuwert: 1.24, horizontal: 1.26, vertikal: 1.22

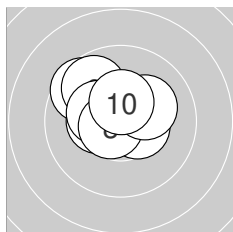
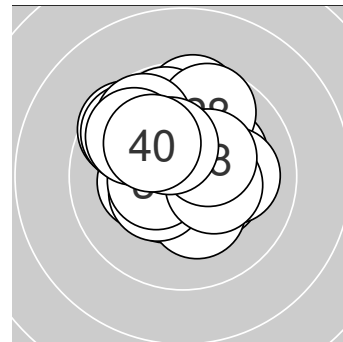

**Serie 1:**

10.5 *	10.5 *	9.6 ↘	10.3 *	10.5 *
9.8 ↘	10.3 *	10.6 *	10.2 *	10.4 *

beste Teiler: 76.4 (8.), 112.6 (2.), 113.7 (5.)  
 Trefferlage: 0.54 mm links, 0.87 mm hoch  
 Streuwert: 1.17, horizontal: 1.37, vertikal: 0.93

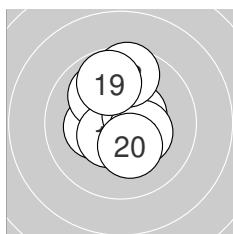

**Serie 2:**

10.6 *	10.3 *	10.5 *	10.0 ↘	10.5 *
10.5 *	10.4 *	9.6 ↑	9.8 ↑	10.3 *

beste Teiler: 89.9 (11.), 107.8 (13.), 111.6 (16.)  
 Trefferlage: 0.02 mm links, 0.37 mm hoch  
 Streuwert: 1.43, horizontal: 1.06, vertikal: 1.72

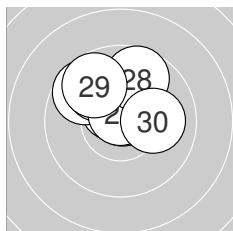

**Serie 3:**

10.5 *	10.2 *	9.7 ↘	10.7 *	9.9 ↘
10.6 *	10.7 *	9.7 ↑	9.7 ↘	10.1 →

beste Teiler: 54.8 (24.), 57.0 (27.), 98.6 (26.)  
 Trefferlage: 0.21 mm links, 1.42 mm hoch  
 Streuwert: 1.24, horizontal: 1.43, vertikal: 1.01

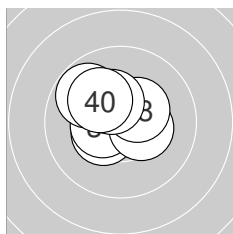

**Serie 4:**

10.7 *	10.5 *	10.4 *	10.5 *	9.8 ↘
10.5 *	10.4 *	10.4 *	10.3 *	10.1 ↘

beste Teiler: 66.7 (31.), 113.2 (36.), 122.7 (32.)  
 Trefferlage: 0.39 mm links, 0.46 mm hoch  
 Streuwert: 1.12, horizontal: 1.28, vertikal: 0.93



Ergebnis: **390.8** (373)  
 Serien: 98.9 97.1 98.0 96.8  
 Zähler: 21 11 8 0 0 0 0 0 0  
 Innenzehner: 13  
 Weitester: 698 (39.), 645 (36.), 601 (24.)  
 beste Teiler: 7.0 (28.), 58.8 (31.), 82.2 (10.)  
 Trefferlage: 0.63 mm links, 0.79 mm hoch  
 Streuwert: 2.35, horizontal: 2.62, vertikal: 2.05

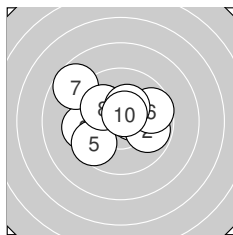
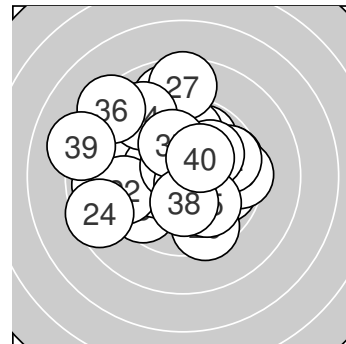

**Serie 1:**  
 10.5 \*                      9.8 →                      9.5 ←                      10.1 ↖                      9.6 ↗  
    9.7 →                      8.7 ↖                      10.1 ↖                      10.3 \*                      10.6 \*  
 beste Teiler: 82.2 (10.), 122.1 (1.), 153.9 (9.)  
 Trefferlage: 0.61 mm links, 0.60 mm hoch  
 Streuwert: 2.11, horizontal: 2.57, vertikal: 1.52

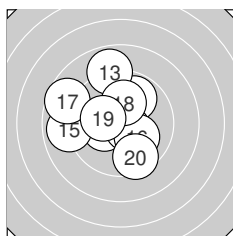

**Serie 2:**  
 10.3 \*                      9.8 ↗                      8.9 ↑                      10.6 \*                      8.9 ←  
    10.1 ↘                      8.7 ↖                      10.1 ↑                      10.2 \*                      9.5 ↘  
 beste Teiler: 88.4 (14.), 167.2 (11.), 179.5 (19.)  
 Trefferlage: 0.93 mm links, 0.58 mm hoch  
 Streuwert: 2.46, horizontal: 2.55, vertikal: 2.38

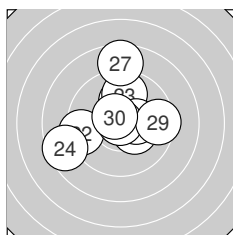

**Serie 3:**  
 10.1 ↑                      9.4 ←                      9.8 ↑                      8.5 ←                      10.3 \*  
    10.3 \*                      8.6 ↑                      10.9 \*                      9.5 →                      10.6 \*  
 beste Teiler: 7.0 (28.), 87.8 (30.), 153.8 (26.)  
 Trefferlage: 0.29 mm links, 0.77 mm hoch  
 Streuwert: 2.51, horizontal: 2.65, vertikal: 2.36

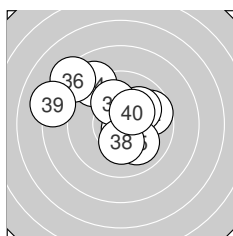

**Serie 4:**  
 10.7 \*                      9.7 →                      10.0 ↗                      9.1 ↖                      10.0 ↘  
    8.4 ↖                      10.1 ↑                      10.3 \*                      8.2 ↖                      10.3 \*  
 beste Teiler: 58.8 (31.), 164.1 (40.), 171.1 (38.)  
 Trefferlage: 0.68 mm links, 1.22 mm hoch  
 Streuwert: 2.63, horizontal: 3.08, vertikal: 2.10



Ergebnis: **402.0** (386)  
 Serien: 99.2 101.1 102.3 99.4  
 Zähler: 27 12 1 0 0 0 0 0 0  
 Innenzehner: 21  
 Weitest: 711 (36.), 453 (3.), 422 (20.)  
 beste Teiler: 68.6 (34.), 81.2 (13.), 86.6 (39.)  
 Trefferlage: 0.19 mm rechts, 0.50 mm tief  
 Streuwert: 1.80, horizontal: 2.13, vertikal: 1.39

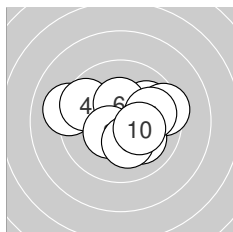
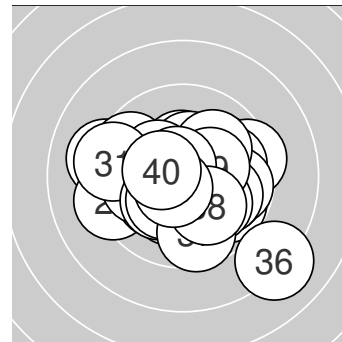

**Serie 1:**  
 9.9 ↗ 9.4 → 9.1 ← 9.6 ↖ 10.1 ↘  
 10.3 \* 9.9 → 10.4 \* 10.2 \* 10.3 \*  
 beste Teiler: 134.3 (8.), 151.3 (6.), 172.5 (10.)  
 Trefferlage: 0.38 mm rechts, 0.20 mm hoch  
 Streuwert: 2.01, horizontal: 2.55, vertikal: 1.26

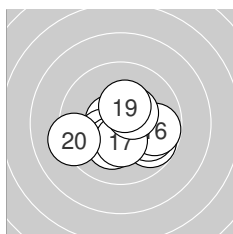

**Serie 2:**  
 9.8 ↘ 9.9 ↘ 10.6 \* 10.3 \* 10.2 \*  
 9.8 → 10.4 \* 10.4 \* 10.4 \* 9.3 ←  
 beste Teiler: 81.2 (13.), 132.5 (18.), 149.0 (17.)  
 Trefferlage: 0.23 mm rechts, 0.61 mm tief  
 Streuwert: 1.69, horizontal: 2.12, vertikal: 1.10

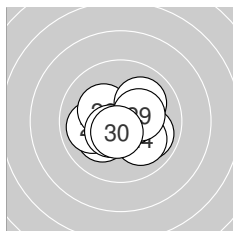

**Serie 3:**  
 9.9 ↘ 10.2 \* 10.0 ← 10.0 ↘ 10.5 \*  
 10.3 \* 10.5 \* 10.0 ↗ 10.3 \* 10.6 \*  
 beste Teiler: 98.3 (30.), 101.1 (25.), 119.5 (27.)  
 Trefferlage: 0.17 mm rechts, 0.28 mm tief  
 Streuwert: 1.40, horizontal: 1.68, vertikal: 1.04

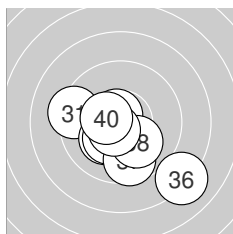

**Serie 4:**  
 9.3 ← 10.1 ↓ 10.2 \* 10.7 \* 10.3 \*  
 8.1 ↘ 9.6 ↓ 10.1 ↘ 10.6 \* 10.4 \*  
 beste Teiler: 68.6 (34.), 86.6 (39.), 126.6 (40.)  
 Trefferlage: 0.02 mm links, 1.32 mm tief  
 Streuwert: 2.09, horizontal: 2.38, vertikal: 1.76





Ergebnis: **396.8** (382)  
 Serien: 98.2 98.8 102.4 97.4  
 Zähler: 24 14 2 0 0 0 0 0 0 0  
 Innenzehner: 15  
 Weitester: 685 (38.), 573 (4.), 494 (8.)  
 beste Teiler: 38.4 (26.), 56.3 (23.), 64.2 (36.)  
 Trefferlage: 0.30 mm links, 0.22 mm hoch  
 Streuwert: 2.13, horizontal: 2.61, vertikal: 1.49

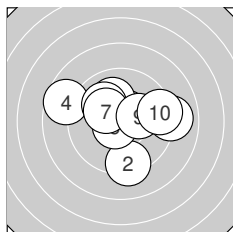
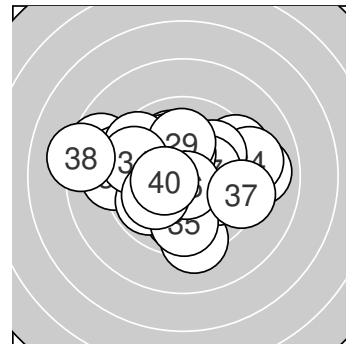

**Serie 1:**  
 10.6 \*                      9.3 ↓                      10.1 ↗                      8.7 ↖                      10.7 \*  
 10.0 ↘                      10.2 \*                      9.0 →                      10.2 \*                      9.4 →  
 beste Teiler: 74.4 (5.), 99.4 (1.), 177.6 (7.)  
 Trefferlage: 0.20 mm rechts, 0.46 mm hoch  
 Streuwert: 2.44, horizontal: 2.95, vertikal: 1.80

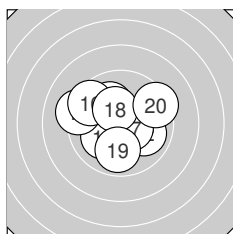

**Serie 2:**  
 9.7 ↖                      10.0 ↘                      10.1 ↗                      10.1 ↘                      9.2 ↖  
 9.5 ↘                      10.5 \*                      10.4 \*                      9.9 ↓                      9.4 →  
 beste Teiler: 110.9 (17.), 148.1 (18.), 214.0 (14.)  
 Trefferlage: 0.69 mm links, 0.36 mm hoch  
 Streuwert: 2.06, horizontal: 2.43, vertikal: 1.61

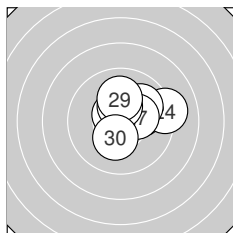

**Serie 3:**  
 10.1 →                      10.6 \*                      10.7 \*                      9.1 →                      10.0 ↗  
 10.8 \*                      10.3 \*                      10.4 \*                      10.1 ↑                      10.3 \*  
 beste Teiler: 38.4 (26.), 56.3 (23.), 89.1 (22.)  
 Trefferlage: 0.95 mm rechts, 0.67 mm hoch  
 Streuwert: 1.32, horizontal: 1.55, vertikal: 1.04

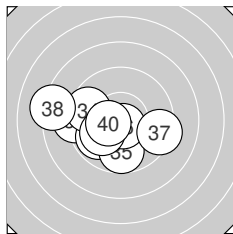

**Serie 4:**  
 9.1 ↖                      10.4 \*                      9.8 ↙                      9.6 ↖                      9.7 ↓  
 10.7 \*                      9.3 →                      8.2 ↖                      10.1 ↙                      10.5 \*  
 beste Teiler: 64.2 (36.), 125.8 (40.), 148.4 (32.)  
 Trefferlage: 1.70 mm links, 0.60 mm tief  
 Streuwert: 2.22, horizontal: 2.87, vertikal: 1.27



Ergebnis: **382.7** (363)  
 Serien: 98.3 98.1 92.7 93.6  
 Zähler: 13 20 5 1 1 0 0 0 0 0  
 Innenzehner: 10  
 Weitester: 1009 (32.), 885 (30.), 604 (17.)  
 beste Teiler: 83.7 (14.), 89.0 (5.), 98.6 (6.)  
 Trefferlage: 0.11 mm links, 0.12 mm hoch  
 Streuwert: 2.83, horizontal: 3.35, vertikal: 2.19

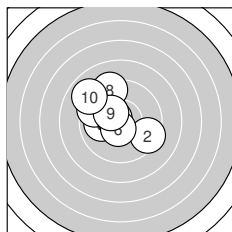
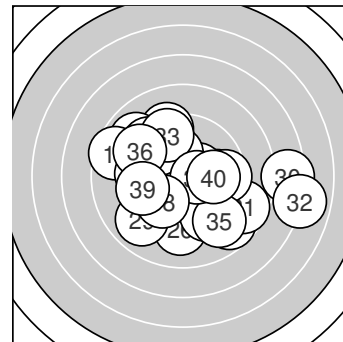

**Serie 1:**  
 10.2 \*                      9.4 ↘                      10.0 ←                      9.5 ↖                      10.6 \*  
 10.6 \*                      9.5 ↙                      9.3 ↑                      10.3 \*                      8.9 ↗  
 beste Teiler: 89.0 (5.), 98.6 (6.), 160.9 (9.)  
 Trefferlage: 1.31 mm links, 1.12 mm hoch  
 Streuwert: 1.94, horizontal: 2.01, vertikal: 1.86

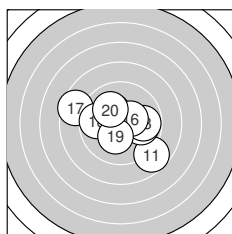

**Serie 2:**  
 8.7 ↘                      9.9 →                      9.8 →                      10.6 \*                      10.2 \*  
 10.4 \*                      8.5 ←                      9.7 ←                      10.2 \*                      10.1 ↙  
 beste Teiler: 83.7 (14.), 137.3 (16.), 177.2 (15.)  
 Trefferlage: 0.15 mm links, 0.05 mm hoch  
 Streuwert: 2.42, horizontal: 2.92, vertikal: 1.77

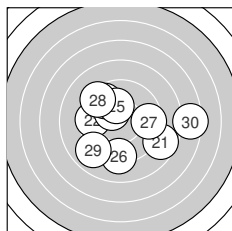

**Serie 3:**  
 8.7 ↘                      9.5 ←                      10.3 \*                      9.7 ↖                      10.1 ↑  
 9.2 ↓                      9.5 →                      9.4 ↘                      8.9 ↗                      7.4 →  
 beste Teiler: 154.8 (23.), 201.3 (25.), 325.4 (24.)  
 Trefferlage: 0.37 mm rechts, 0.21 mm tief  
 Streuwert: 3.43, horizontal: 4.13, vertikal: 2.54

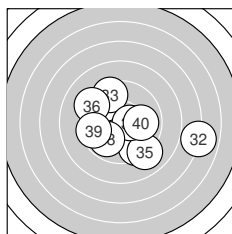

**Serie 4:**  
 9.7 ↖                      6.9 →                      9.5 ↖                      9.4 ↘                      9.0 ↘  
 9.3 ↖                      10.5 \*                      9.9 ↗                      9.5 ←                      9.9 →  
 beste Teiler: 117.4 (37.), 258.0 (40.), 275.0 (38.)  
 Trefferlage: 0.65 mm rechts, 0.45 mm tief  
 Streuwert: 3.36, horizontal: 4.06, vertikal: 2.47



Ergebnis: **399.3** (382)  
 Serien: 100.1 100.7 100.8 97.7  
 Zähler: 23 16 1 0 0 0 0 0 0  
 Innenzehner: 17  
 Weitester: 735 (32.), 455 (34.), 413 (2.)  
 beste Teiler: 6.3 (25.), 35.0 (28.), 75.2 (5.)  
 Trefferlage: 0.11 mm links, 0.57 mm hoch  
 Streuwert: 1.93, horizontal: 2.13, vertikal: 1.72

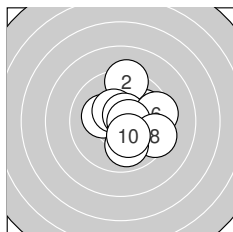
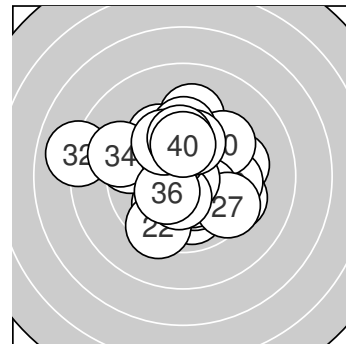

**Serie 1:**  
 9.9 ↗                      9.3 ↑                      10.2 \*                      10.4 \*                      10.7 \*  
 9.4 ↗                      10.6 \*                      9.4 ↘                      9.9 ↓                      10.3 \*  
 beste Teiler: 75.2 (5.), 83.0 (7.), 127.8 (4.)  
 Trefferlage: 1.03 mm rechts, 0.27 mm hoch  
 Streuwert: 1.78, horizontal: 1.73, vertikal: 1.82

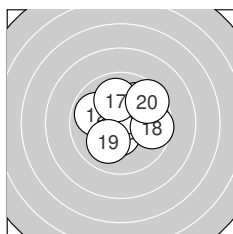

**Serie 2:**  
 10.2 \*                      9.9 ↖                      10.5 \*                      10.0 ↗                      10.6 \*  
 10.4 \*                      10.0 ↑                      9.6 →                      10.0 ↙                      9.5 ↗  
 beste Teiler: 81.3 (15.), 118.0 (13.), 148.8 (16.)  
 Trefferlage: 0.29 mm rechts, 0.67 mm hoch  
 Streuwert: 1.67, horizontal: 1.87, vertikal: 1.43

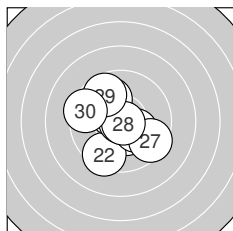

**Serie 3:**  
 10.4 \*                      9.4 ↙                      10.2 \*                      10.5 \*                      10.9 \*  
 10.0 ↘                      9.5 ↘                      10.8 \*                      9.7 ↘                      9.4 ↖  
 beste Teiler: 6.3 (25.), 35.0 (28.), 112.4 (24.)  
 Trefferlage: 0.33 mm links, 0.11 mm tief  
 Streuwert: 1.88, horizontal: 1.88, vertikal: 1.89

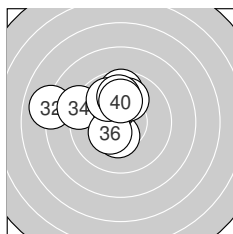

**Serie 4:**  
 9.7 ↑                      8.0 ↖                      10.4 \*                      9.1 ↖                      10.3 \*  
 10.3 \*                      9.9 ↘                      10.0 ↑                      9.9 ↑                      10.1 ↑  
 beste Teiler: 145.5 (33.), 151.3 (36.), 155.2 (35.)  
 Trefferlage: 1.43 mm links, 1.46 mm hoch  
 Streuwert: 2.04, horizontal: 2.44, vertikal: 1.53



Ergebnis: **398.2** (378)  
 Serien: 101.8 101.6 96.2 98.6  
 Zähler: 20 18 2 0 0 0 0 0 0  
 Innenzehner: 13  
 Weitester: 544 (25.), 529 (36.), 491 (23.)  
 beste Teiler: 73.0 (3.), 83.0 (2.), 86.4 (14.)  
 Trefferlage: 0.09 mm links, 0.60 mm hoch  
 Streuwert: 1.91, horizontal: 1.58, vertikal: 2.20

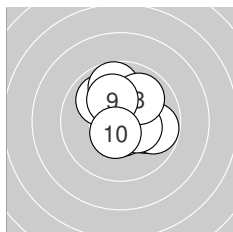
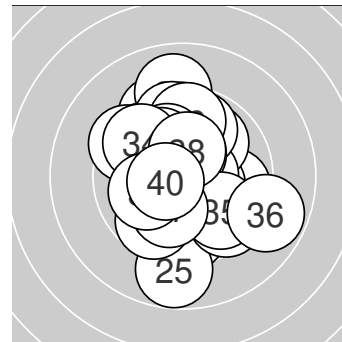

**Serie 1:**  
 10.1 ↗ 10.6 \* 10.7 \* 10.0 ↘ 9.7 ↑  
 9.8 ↗ 10.4 \* 9.9 ↗ 10.1 ↖ 10.5 \*  
 beste Teiler: 73.0 (3.), 83.0 (2.), 109.6 (10.)  
 Trefferlage: 0.44 mm rechts, 0.58 mm hoch  
 Streuwert: 1.46, horizontal: 1.46, vertikal: 1.46

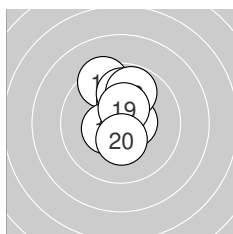

**Serie 2:**  
 9.4 ↘ 10.2 \* 9.9 ↑ 10.6 \* 9.9 ↑  
 10.6 \* 10.4 \* 9.8 ↑ 10.4 \* 10.4 \*  
 beste Teiler: 86.4 (14.), 99.4 (16.), 126.6 (17.)  
 Trefferlage: 0.06 mm rechts, 1.36 mm hoch  
 Streuwert: 1.27, horizontal: 0.81, vertikal: 1.60

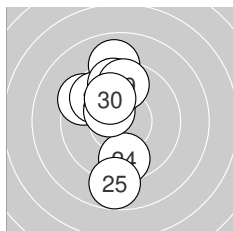

**Serie 3:**  
 9.9 ↑ 9.4 ↘ 9.0 ↑ 9.6 ↓ 8.8 ↓  
 9.7 ↘ 10.4 \* 9.6 ↑ 9.7 ↑ 10.1 ↖  
 beste Teiler: 131.7 (27.), 218.3 (30.), 253.0 (21.)  
 Trefferlage: 0.91 mm links, 1.19 mm hoch  
 Streuwert: 2.35, horizontal: 1.08, vertikal: 3.15

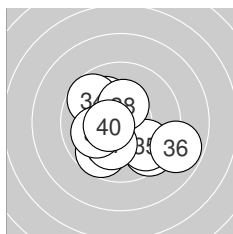

**Serie 4:**  
 10.1 ↘ 9.5 ↘ 9.7 ↙ 9.7 ↘ 9.8 ↘  
 8.8 ↗ 10.1 ↙ 10.4 \* 10.0 ↖ 10.5 \*  
 beste Teiler: 106.6 (40.), 150.9 (38.), 207.0 (37.)  
 Trefferlage: 0.04 mm rechts, 0.71 mm tief  
 Streuwert: 2.12, horizontal: 2.38, vertikal: 1.83



**Ergebnis:** **384.5** (365)  
**Serien:** 94.6 96.1 96.9 96.9  
**Zähler:** 16 14 9 1 0 0 0 0 0 0  
**Innenzehner:** 10  
**Weiteste:** 938 (27.), 701 (19.), 678 (16.)  
**beste Teiler:** 18.4 (13.), 61.0 (24.), 68.6 (23.)  
**Trefferlage:** 0.55 mm rechts, 0.02 mm hoch  
**Streuwert:** 2.77, horizontal: 3.17, vertikal: 2.30

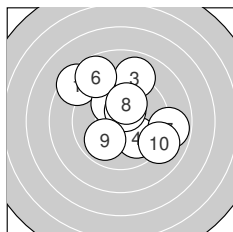
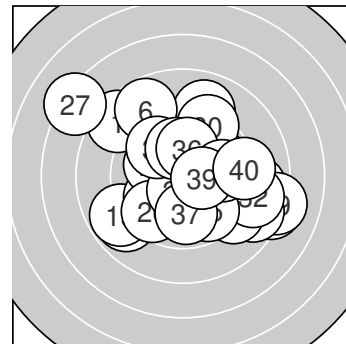

**Serie 1:**  
 8.5 ↘                      10.1 ↘                      9.0 ↑                      10.0 ↘                      10.5 \*  
 8.7 ↘                      8.8 →                      10.1 ↑                      9.9 ↗                      9.0 ↘  
**beste Teiler:** 123.1 (5.), 202.0 (8.), 212.4 (2.)  
**Trefferlage:** 0.36 mm rechts, 1.16 mm hoch  
**Streuwert:** 2.90, horizontal: 3.03, vertikal: 2.77

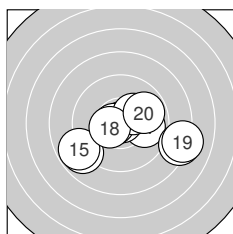

**Serie 2:**  
 9.9 →                      8.9 ↙                      10.9 \*                      10.7 \*                      8.8 ↙  
 8.2 →                      10.3 \*                      10.5 \*                      8.1 →                      9.8 →  
**beste Teiler:** 18.4 (13.), 72.6 (14.), 125.9 (18.)  
**Trefferlage:** 0.92 mm rechts, 0.90 mm tief  
**Streuwert:** 2.92, horizontal: 3.82, vertikal: 1.57

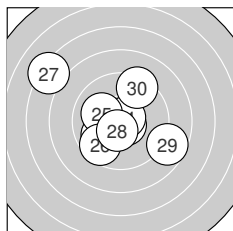

**Serie 3:**  
 9.9 ↙                      10.2 \*                      10.7 \*                      10.7 \*                      10.1 ↘  
 9.6 ↙                      7.2 ↘                      10.5 \*                      8.7 →                      9.3 ↑  
**beste Teiler:** 61.0 (24.), 68.6 (23.), 108.5 (28.)  
**Trefferlage:** 0.79 mm links, 0.09 mm hoch  
**Streuwert:** 2.96, horizontal: 3.32, vertikal: 2.55

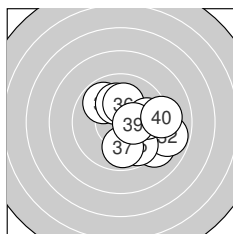

**Serie 4:**  
 9.1 ↘                      8.8 →                      9.8 ↘                      10.1 ↑                      9.7 ↘  
 10.1 ↑                      9.9 ↓                      9.8 →                      10.4 \*                      9.2 →  
**beste Teiler:** 137.7 (39.), 202.3 (36.), 204.7 (34.)  
**Trefferlage:** 1.74 mm rechts, 0.24 mm tief  
**Streuwert:** 2.11, horizontal: 2.25, vertikal: 1.96



Ergebnis: **375.9** (355)  
 Serien: 92.7 92.7 95.3 95.2  
 Zähler: 6 24 9 1 0 0 0 0 0  
 Innenzehner: 3  
 Weitestе: 885 (6.), 667 (23.), 656 (20.)  
 beste Teiler: 158.1 (30.), 199.7 (5.), 199.8 (22.)  
 Trefferlage: 0.13 mm links, 0.76 mm tief  
 Streuwert: 2.96, horizontal: 3.49, vertikal: 2.31

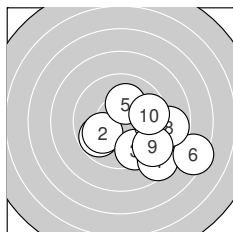
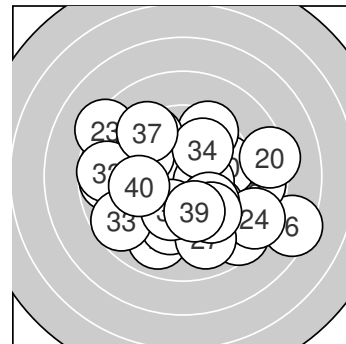

**Serie 1:**  
 9.8 ↙                      10.0 ↙                      9.5 ↘                      8.6 ↘                      10.2 \*  
 7.4 ↘                      9.5 →                      8.8 →                      9.2 ↘                      9.7 →  
 beste Teiler: 199.7 (5.), 237.9 (2.), 292.4 (1.)  
 Trefferlage: 2.56 mm rechts, 1.49 mm tief  
 Streuwert: 2.69, horizontal: 3.22, vertikal: 2.02

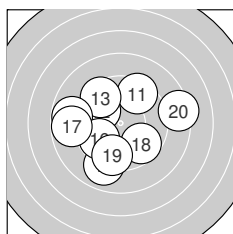

**Serie 2:**  
 9.4 ↗                      9.9 ↘                      9.5 ↘                      9.0 ↓                      8.8 ←  
 9.8 ↙                      8.8 ←                      9.7 ↘                      9.5 ↓                      8.3 →  
 beste Teiler: 263.9 (12.), 293.2 (16.), 318.2 (18.)  
 Trefferlage: 0.98 mm links, 0.28 mm tief  
 Streuwert: 3.18, horizontal: 3.62, vertikal: 2.68

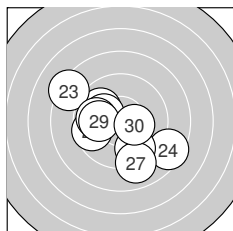

**Serie 3:**  
 9.9 ↘                      10.2 \*                      8.3 ↘                      8.5 ↘                      9.6 ←  
 9.6 ↘                      9.0 ↓                      9.9 ←                      10.0 ←                      10.3 \*  
 beste Teiler: 158.1 (30.), 199.8 (22.), 239.0 (29.)  
 Trefferlage: 0.79 mm links, 0.61 mm tief  
 Streuwert: 2.84, horizontal: 3.22, vertikal: 2.40

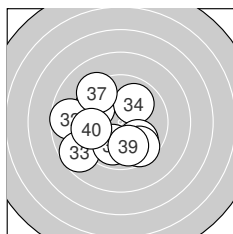

**Serie 4:**  
 9.6 ↘                      8.7 ←                      8.7 ↙                      10.0 ↗                      9.9 ↘  
 9.9 ↓                      9.3 ↘                      9.6 ↘                      9.9 ↓                      9.6 ←  
 beste Teiler: 250.0 (34.), 263.7 (36.), 273.5 (39.)  
 Trefferlage: 1.34 mm links, 0.66 mm tief  
 Streuwert: 2.58, horizontal: 2.82, vertikal: 2.31



Ergebnis: **388.3** (371)  
 Serien: 100.2 95.6 93.4 99.1  
 Zähler: 18 16 5 1 0 0 0 0 0 0  
 Innenzehner: 13  
 Weitester: 764 (24.), 676 (28.), 626 (20.)  
 beste Teiler: 50.0 (10.), 59.9 (12.), 70.7 (5.)  
 Trefferlage: 0.68 mm rechts, 0.61 mm hoch  
 Streuwert: 2.48, horizontal: 2.81, vertikal: 2.11

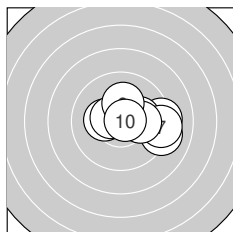
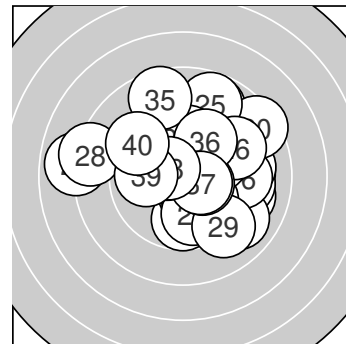

**Serie 1:**  
 9.2 →                      10.3 \*                      10.5 \*                      9.1 →                      10.7 \*  
 10.1 →                      9.2 →                      10.1 →                      10.2 \*                      10.8 \*  
 beste Teiler: 50.0 (10.), 70.7 (5.), 108.2 (3.)  
 Trefferlage: 1.57 mm rechts, 0.14 mm hoch  
 Streuwert: 1.68, horizontal: 2.22, vertikal: 0.83

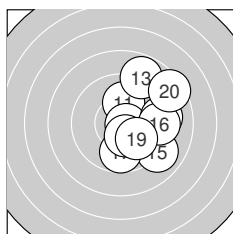

**Serie 2:**  
 10.1 ↑                      10.7 \*                      8.8 ↑                      9.2 →                      9.0 ↘  
 9.3 →                      9.7 ↓                      10.4 \*                      10.0 ↘                      8.4 ↗  
 beste Teiler: 59.9 (12.), 144.3 (18.), 221.3 (11.)  
 Trefferlage: 2.28 mm rechts, 0.18 mm hoch  
 Streuwert: 2.33, horizontal: 1.95, vertikal: 2.65

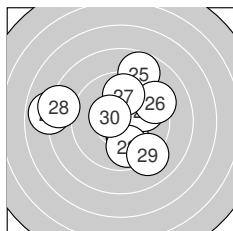

**Serie 3:**  
 10.2 \*                      9.9 ↗                      9.8 ↓                      7.9 ←                      8.8 ↑  
 9.3 ↗                      9.8 ↑                      8.2 ←                      9.1 ↘                      10.4 \*  
 beste Teiler: 126.6 (30.), 178.1 (21.), 268.8 (22.)  
 Trefferlage: 0.26 mm links, 0.61 mm hoch  
 Streuwert: 3.30, horizontal: 3.87, vertikal: 2.61

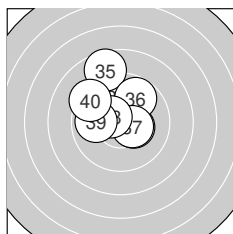

**Serie 4:**  
 10.4 \*                      9.7 ↘                      10.0 ←                      10.4 \*                      8.6 ↑  
 9.8 ↗                      10.4 \*                      10.5 \*                      9.9 ←                      9.4 ↘  
 beste Teiler: 116.3 (38.), 129.6 (31.), 134.8 (37.)  
 Trefferlage: 0.85 mm links, 1.48 mm hoch  
 Streuwert: 1.80, horizontal: 1.75, vertikal: 1.86



Ergebnis: **390.2** (371)  
 Serien: 99.9 97.3 97.2 95.8  
 Zähler: 15 21 4 0 0 0 0 0 0  
 Innenzehner: 13  
 Weitester: 698 (35.), 624 (19.), 599 (2.)  
 beste Teiler: 38.0 (11.), 51.9 (8.), 92.0 (6.)  
 Trefferlage: 0.40 mm links, 1.10 mm tief  
 Streuwert: 2.25, horizontal: 2.39, vertikal: 2.11

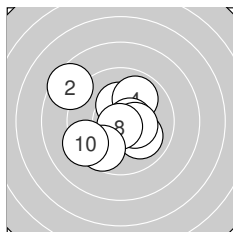
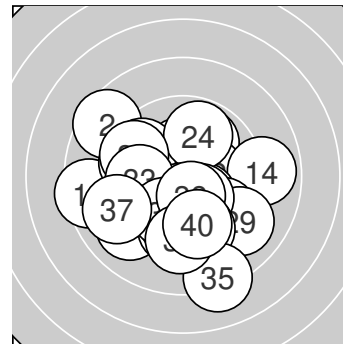

**Serie 1:**  
 10.4 \*                      8.6 ↘                      10.3 \*                      9.9 ↗                      10.0 ↘  
 10.6 \*                      10.4 \*                      10.7 \*                      9.7 ↙                      9.3 ↙  
 beste Teiler: 51.9 (8.), 92.0 (6.), 130.8 (1.)  
 Trefferlage: 0.39 mm links, 0.10 mm hoch  
 Streuwert: 2.12, horizontal: 2.29, vertikal: 1.93

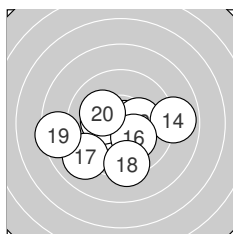

**Serie 2:**  
 10.8 \*                      10.2 \*                      9.8 ↓                      8.9 →                      10.3 \*  
 10.2 \*                      9.1 ↙                      9.4 ↓                      8.5 ←                      10.1 ↘  
 beste Teiler: 38.0 (11.), 170.0 (15.), 178.6 (12.)  
 Trefferlage: 0.37 mm links, 1.08 mm tief  
 Streuwert: 2.51, horizontal: 3.09, vertikal: 1.73

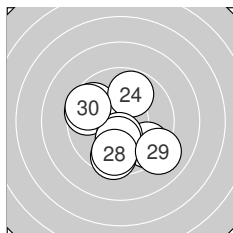

**Serie 3:**  
 9.6 ↘                      9.7 ↘                      9.6 ←                      9.8 ↗                      9.5 ↓  
 10.4 \*                      10.2 \*                      9.7 ↓                      9.1 ↘                      9.6 ↙  
 beste Teiler: 140.6 (26.), 180.6 (27.), 282.8 (24.)  
 Trefferlage: 0.34 mm links, 0.85 mm tief  
 Streuwert: 2.29, horizontal: 2.33, vertikal: 2.24

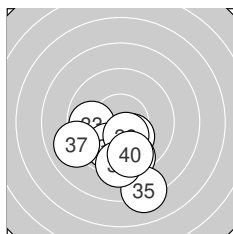

**Serie 4:**  
 9.9 ↙                      10.2 \*                      9.8 ←                      9.5 ↓                      8.2 ↓  
 9.9 ↙                      9.0 ↙                      10.4 \*                      9.3 ↓                      9.6 ↓  
 beste Teiler: 139.0 (38.), 178.4 (32.), 260.1 (31.)  
 Trefferlage: 0.48 mm links, 2.59 mm tief  
 Streuwert: 1.97, horizontal: 2.10, vertikal: 1.83





Ergebnis: **405.3** (387)  
 Serien: 95.6 103.7 101.9 104.1  
 Zähler: 30 8 1 1 0 0 0 0 0 0  
 Innenzehner: 25  
 Weitester: 773 (3.), 532 (2.), 459 (13.)  
 beste Teiler: 29.0 (11.), 47.4 (34.), 47.5 (16.)  
 Trefferlage: 0.32 mm rechts, 0.53 mm hoch  
 Streuwert: 1.79, horizontal: 2.25, vertikal: 1.14

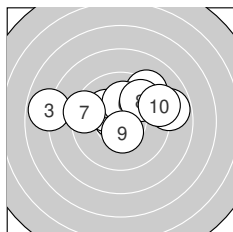
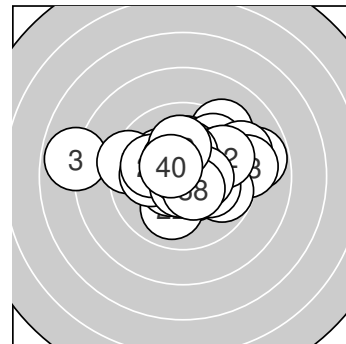

**Serie 1:**  
 10.6 \*                      8.8 →                      7.9 ←                      9.3 ↗                      10.2 \*  
 10.1 ↑                      9.3 ←                      9.7 ↗                      10.5 \*                      9.2 →  
 beste Teiler: 84.2 (1.), 116.7 (9.), 193.6 (5.)  
 Trefferlage: 0.08 mm rechts, 1.30 mm hoch  
 Streuwert: 2.84, horizontal: 3.84, vertikal: 1.16

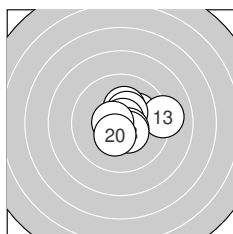

**Serie 2:**  
 10.8 \*                      10.2 \*                      9.1 →                      10.3 \*                      10.4 \*  
 10.8 \*                      10.6 \*                      10.5 \*                      10.6 \*                      10.4 \*  
 beste Teiler: 29.0 (11.), 47.5 (16.), 85.5 (19.)  
 Trefferlage: 0.76 mm rechts, 0.19 mm hoch  
 Streuwert: 1.27, horizontal: 1.52, vertikal: 0.96

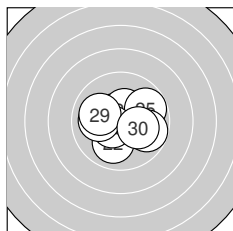

**Serie 3:**  
 10.5 \*                      10.0 ↓                      10.7 \*                      10.4 \*                      9.8 →  
 10.5 \*                      9.8 →                      10.0 ←                      10.0 ←                      10.2 \*  
 beste Teiler: 71.0 (23.), 107.8 (26.), 108.4 (21.)  
 Trefferlage: 0.12 mm rechts, 0.01 mm tief  
 Streuwert: 1.53, horizontal: 1.85, vertikal: 1.13

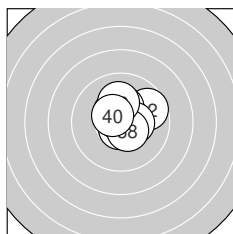

**Serie 4:**  
 10.6 \*                      9.7 →                      10.7 \*                      10.8 \*                      10.3 \*  
 10.5 \*                      10.4 \*                      10.5 \*                      10.1 ↑                      10.5 \*  
 beste Teiler: 47.4 (34.), 70.2 (33.), 99.0 (31.)  
 Trefferlage: 0.30 mm rechts, 0.65 mm hoch  
 Streuwert: 1.05, horizontal: 1.11, vertikal: 0.97



Ergebnis: **328.1** (312)  
 Serien: 78.3 88.9 83.6 77.3  
 Zähler: 6 8 12 6 5 1 1 1 0 0  
 Innenzehner: 5  
 Weitester: 1854 (6.), 1550 (33.), 1252 (31.)  
 beste Teiler: 29.0 (9.), 129.8 (25.), 177.3 (19.)  
 Trefferlage: 0.45 mm links, 1.90 mm hoch  
 Streuwert: 5.48, horizontal: 6.41, vertikal: 4.36

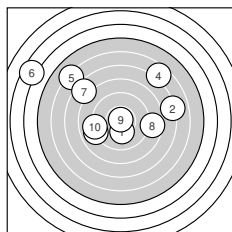
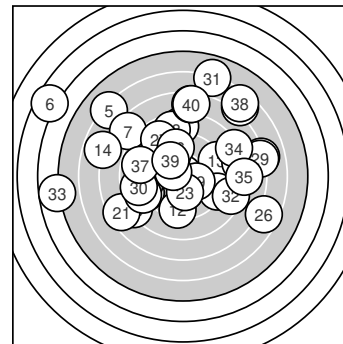

**Serie 1:**  
 10.2 \*                      7.0 →                      9.0 ←                      6.6 ↗                      6.1 ↘  
    3.5 ↙                      7.5 ↙                      8.6 →                      10.8 \*                      9.0 ←  
 beste Teiler: 29.0 (9.), 190.7 (1.), 481.7 (10.)  
 Trefferlage: 1.86 mm links, 2.78 mm hoch  
 Streuwert: 6.48, horizontal: 7.98, vertikal: 4.50

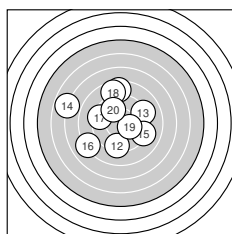

**Serie 2:**  
 8.5 ↑                      9.3 ↓                      9.1 ↗                      6.8 ↖                      9.1 ↘  
    8.1 ↙                      9.4 ↖                      8.6 ↑                      10.2 \*                      9.8 ↘  
 beste Teiler: 177.3 (19.), 281.0 (20.), 396.5 (17.)  
 Trefferlage: 1.33 mm links, 0.98 mm hoch  
 Streuwert: 4.00, horizontal: 4.35, vertikal: 3.63

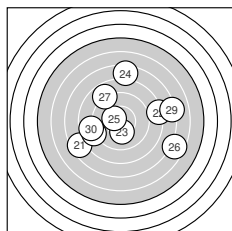

**Serie 3:**  
 7.5 ←                      8.1 →                      10.2 \*                      7.4 ↑                      10.4 \*  
    6.6 ↘                      8.8 ↘                      8.8 ←                      7.1 →                      8.7 ←  
 beste Teiler: 129.8 (25.), 196.5 (23.), 534.5 (27.)  
 Trefferlage: 0.55 mm rechts, 0.29 mm hoch  
 Streuwert: 5.31, horizontal: 6.26, vertikal: 4.16

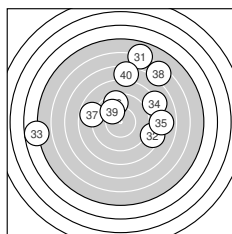

**Serie 4:**  
 5.9 ↑                      8.4 ↘                      4.8 ←                      8.1 ↗                      8.0 →  
    9.5 ↑                      8.8 ↖                      6.4 ↗                      10.0 ↘                      7.4 ↑  
 beste Teiler: 245.6 (39.), 360.8 (36.), 539.9 (37.)  
 Trefferlage: 0.81 mm rechts, 3.53 mm hoch  
 Streuwert: 6.09, horizontal: 7.08, vertikal: 4.89



Ergebnis: **348.8** (332)  
 Serien: 88.0 89.7 85.3 85.8  
 Zähler: 8 12 9 7 3 1 0 0 0 0  
 Innenzehner: 6  
 Weitester: 1370 (28.), 1210 (38.), 1064 (9.)  
 beste Teiler: 41.1 (29.), 133.1 (24.), 159.7 (6.)  
 Trefferlage: 0.14 mm rechts, 2.00 mm hoch  
 Streuwert: 4.35, horizontal: 4.36, vertikal: 4.34

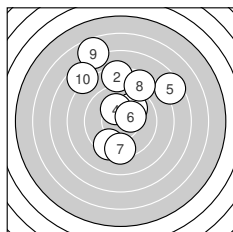
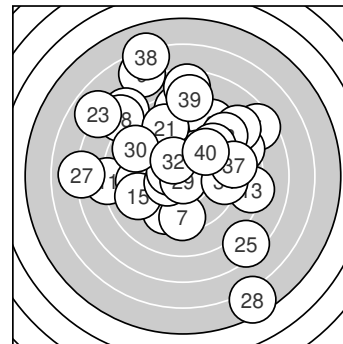

**Serie 1:**  
 9.4 ↙                      8.3 ↑                      10.0 ↗  
 10.3 \*                      9.4 ↓                      8.6 ↖  
 beste Teiler: 159.7 (6.), 187.7 (4.), 248.7 (3.)  
 Trefferlage: 0.05 mm rechts, 2.95 mm hoch  
 Streuwert: 4.01, horizontal: 3.55, vertikal: 4.42

10.2 \*                      7.5 ↗  
 6.7 ↘                      7.6 ↘

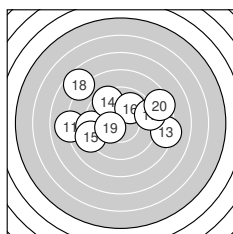

**Serie 2:**  
 8.0 ←                      9.2 ←                      8.3 →  
 9.9 ↗                      9.2 →                      7.7 ↘  
 beste Teiler: 163.6 (19.), 259.0 (16.), 362.7 (14.)  
 Trefferlage: 0.74 mm links, 0.99 mm hoch  
 Streuwert: 3.90, horizontal: 4.97, vertikal: 2.37

9.5 ↘                      9.1 ←  
 10.3 \*                      8.5 ↗

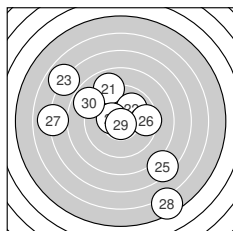

**Serie 3:**  
 9.0 ↘                      10.0 ↗                      6.9 ↘  
 9.5 →                      7.0 ←                      5.5 ↘  
 beste Teiler: 41.1 (29.), 133.1 (24.), 242.4 (22.)  
 Trefferlage: 0.74 mm links, 0.30 mm tief  
 Streuwert: 5.45, horizontal: 5.60, vertikal: 5.30

10.4 \*                      7.4 ↘  
 10.8 \*                      8.8 ↘

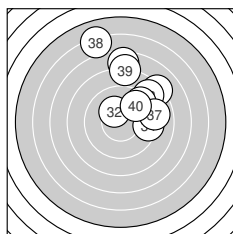

**Serie 4:**  
 8.2 ↗                      10.2 \*                      8.7 ↗  
 9.3 ↗                      8.9 →                      6.1 ↘  
 beste Teiler: 176.3 (32.), 321.9 (40.), 405.8 (34.)  
 Trefferlage: 1.98 mm rechts, 4.35 mm hoch  
 Streuwert: 3.34, horizontal: 2.83, vertikal: 3.78

9.3 →                      7.5 ↑  
 7.9 ↑                      9.7 ↗



Ergebnis: **386.0** (369)  
 Serien: 96.5 93.9 97.5 98.1  
 Zähler: 15 19 6 0 0 0 0 0 0 0  
 Innenzehner: 9  
 Weitestе: 651 (7.), 629 (16.), 611 (13.)  
 beste Teiler: 90.9 (25.), 100.9 (40.), 134.4 (2.)  
 Trefferlage: 0.10 mm rechts, 0.42 mm tief  
 Streuwert: 2.56, horizontal: 3.02, vertikal: 2.00

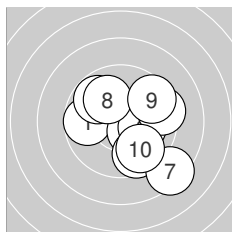
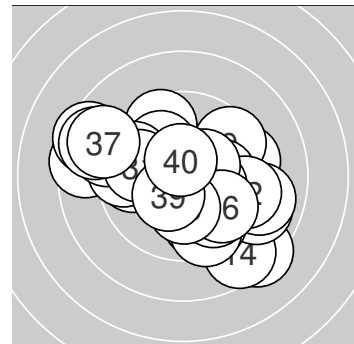

**Serie 1:**

9.7 ←	10.4 *	10.1 →	9.6 ↓	9.8 ↖
9.4 →	8.3 ↘	10.0 ↗	9.5 ↗	9.7 ↘

beste Teiler: 134.4 (2.), 208.6 (3.), 235.9 (8.)  
 Trefferlage: 1.11 mm rechts, 0.46 mm tief  
 Streuwert: 2.44, horizontal: 2.53, vertikal: 2.34

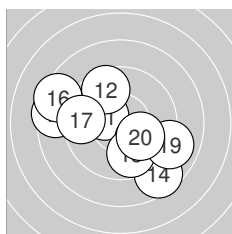

**Serie 2:**

10.3 *	9.6 ↘	8.5 ←	8.6 ↓	10.1 ↘
8.4 ↖	9.5 ←	9.8 ↓	9.0 →	10.1 ↘

beste Teiler: 162.4 (11.), 220.2 (20.), 225.4 (15.)  
 Trefferlage: 0.58 mm links, 0.47 mm tief  
 Streuwert: 3.14, horizontal: 3.73, vertikal: 2.40

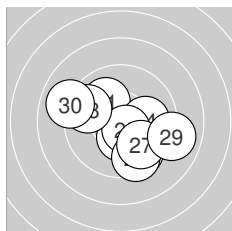

**Serie 3:**

10.0 ↘	10.4 *	9.6 ↓	10.0 →	10.6 *
9.5 ↓	9.8 ↘	9.6 ↖	9.0 →	9.0 ↖

beste Teiler: 90.9 (25.), 149.0 (22.), 226.4 (21.)  
 Trefferlage: 0.34 mm rechts, 0.74 mm tief  
 Streuwert: 2.35, horizontal: 2.76, vertikal: 1.84

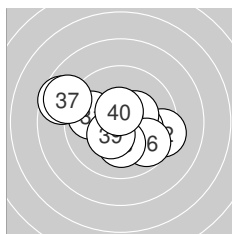

**Serie 4:**

9.8 ←	9.4 →	10.2 *	10.4 *	8.6 ↖
9.7 ↘	8.8 ↖	10.2 *	10.4 *	10.6 *

beste Teiler: 100.9 (40.), 146.2 (34.), 146.8 (39.)  
 Trefferlage: 0.47 mm links, 0.01 mm tief  
 Streuwert: 2.43, horizontal: 3.08, vertikal: 1.51



Ergebnis: **337.4** (318)  
 Serien: 84.8 84.5 75.5 92.6  
 Zähler: 8 10 8 7 2 4 0 1 0 0  
 Innenzehner: 6  
 Weitester: 1830 (21.), 1434 (5.), 1412 (27.)  
 beste Teiler: 51.0 (8.), 76.5 (3.), 80.1 (34.)  
 Trefferlage: 1.14 mm links, 1.93 mm hoch  
 Streuwert: 5.18, horizontal: 5.22, vertikal: 5.15

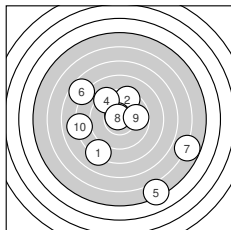
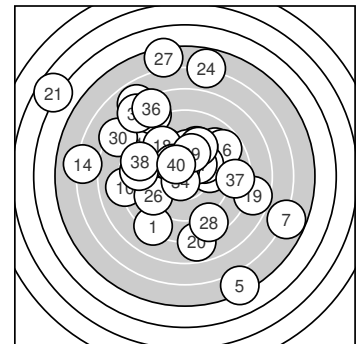

**Serie 1:**

8.2 ↙	9.4 ↗	10.6 *	9.3 ↘	5.2 ↓
7.7 ↘	5.8 ↘	10.7 *	9.8 →	8.1 ←

beste Teiler: 51.0 (8.), 76.5 (3.), 291.9 (9.)  
 Trefferlage: 0.20 mm rechts, 1.18 mm tief  
 Streuwert: 5.61, horizontal: 5.84, vertikal: 5.37

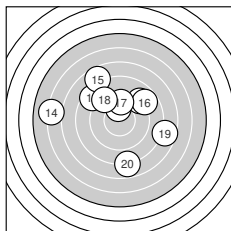

**Serie 2:**

8.5 ↘	10.1 ↑	9.0 ↗	6.1 ←	7.7 ↘
8.8 ↗	9.7 ↑	9.2 ↘	7.6 →	7.8 ↓

beste Teiler: 203.3 (12.), 318.8 (17.), 447.4 (18.)  
 Trefferlage: 0.60 mm links, 1.79 mm hoch  
 Streuwert: 4.91, horizontal: 5.61, vertikal: 4.09

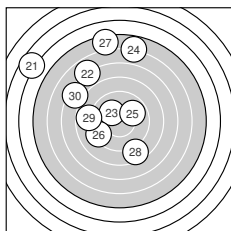

**Serie 3:**

3.6 ↘	6.9 ↘	10.2 *	5.8 ↑	9.9 ↗
9.2 ↙	5.3 ↑	8.5 ↘	8.8 ←	7.3 ↘

beste Teiler: 200.9 (23.), 267.7 (25.), 435.1 (26.)  
 Trefferlage: 3.43 mm links, 4.51 mm hoch  
 Streuwert: 6.06, horizontal: 5.62, vertikal: 6.47

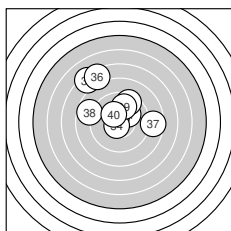

**Serie 4:**

10.1 ↗	10.5 *	9.4 ↗	10.6 *	7.2 ↘
7.4 ↘	8.6 →	8.7 ↙	9.8 ↑	10.3 *

beste Teiler: 80.1 (34.), 106.5 (32.), 171.4 (40.)  
 Trefferlage: 0.72 mm links, 2.60 mm hoch  
 Streuwert: 3.25, horizontal: 3.53, vertikal: 2.94



Ergebnis: **371.4** (355)  
 Serien: 99.5 88.7 92.4 90.8  
 Zähler: 12 14 11 3 0 0 0 0 0 0  
 Innenzehner: 9  
 Weitester: 850 (29.), 833 (31.), 753 (23.)  
 beste Teiler: 81.4 (24.), 95.3 (9.), 103.5 (4.)  
 Trefferlage: 0.25 mm rechts, 1.36 mm hoch  
 Streuwert: 3.22, horizontal: 3.99, vertikal: 2.21

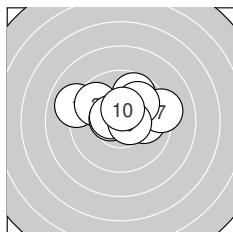
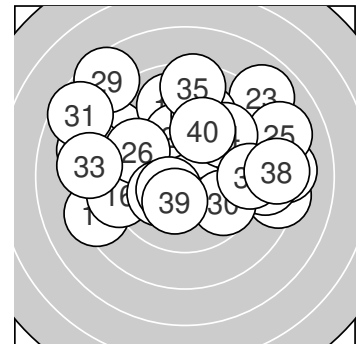

**Serie 1:**  
 9.0 ↙                      9.7 ↗                      9.7 ↘                      10.5 \*                      10.0 →  
 10.5 \*                      9.2 →                      9.9 ↗                      10.6 \*                      10.4 \*  
 beste Teiler: 95.3 (9.), 103.5 (4.), 105.6 (6.)  
 Trefferlage: 0.17 mm rechts, 1.07 mm hoch  
 Streuwert: 1.91, horizontal: 2.53, vertikal: 0.94

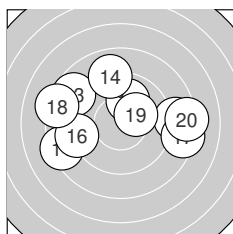

**Serie 2:**  
 8.3 ↙                      10.0 ↗                      8.7 ↘                      9.0 ↑                      8.7 →  
 9.1 ↙                      8.3 →                      8.2 ↙                      10.2 \*                      8.2 →  
 beste Teiler: 180.4 (19.), 244.7 (12.), 468.5 (16.)  
 Trefferlage: 0.18 mm links, 0.84 mm hoch  
 Streuwert: 4.02, horizontal: 5.24, vertikal: 2.22

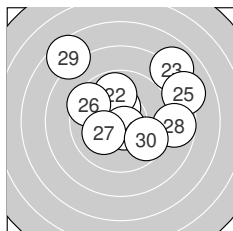

**Serie 3:**  
 10.4 \*                      9.8 ↑                      7.9 ↗                      10.6 \*                      8.1 →  
 9.5 ↙                      10.1 ↙                      8.7 →                      7.6 ↘                      9.7 ↘  
 beste Teiler: 81.4 (24.), 139.1 (21.), 209.4 (27.)  
 Trefferlage: 0.91 mm rechts, 1.65 mm hoch  
 Streuwert: 3.44, horizontal: 3.97, vertikal: 2.81

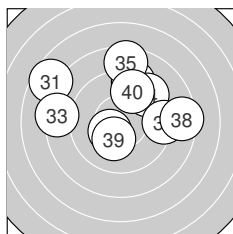

**Serie 4:**  
 7.6 ↘                      9.2 ↗                      8.3 ←                      9.4 ↗                      8.5 ↑  
 9.2 →                      10.4 \*                      8.4 →                      10.2 \*                      9.6 ↑  
 beste Teiler: 144.8 (37.), 185.6 (39.), 337.4 (40.)  
 Trefferlage: 0.10 mm rechts, 1.88 mm hoch  
 Streuwert: 3.54, horizontal: 4.30, vertikal: 2.57



Ergebnis: **385.0** (371)  
 Serien: 93.4 96.1 98.9 96.6  
 Zähler: 16 20 3 1 0 0 0 0 0 0  
 Innenzehner: 10  
 Weitester: 783 (39.), 747 (8.), 563 (19.)  
 beste Teiler: 28.6 (20.), 56.4 (30.), 120.5 (34.)  
 Trefferlage: 0.58 mm links, 0.55 mm hoch  
 Streuwert: 2.59, horizontal: 3.14, vertikal: 1.90

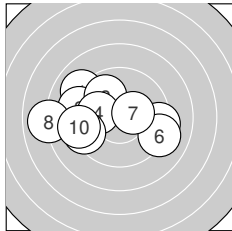
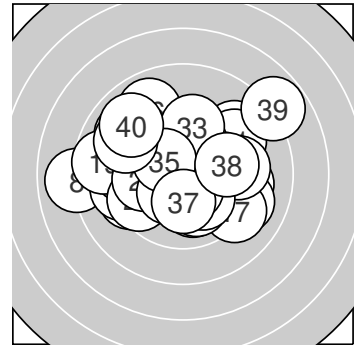

**Serie 1:**

9.0 ↘	9.2 ←	9.9 ↗	10.0 ←	9.3 →
9.1 ↘	10.4 *	8.0 ←	9.3 ←	9.2 ←

beste Teiler: 149.2 (7.), 229.4 (4.), 268.1 (3.)  
 Trefferlage: 1.77 mm links, 0.12 mm hoch  
 Streuwert: 2.95, horizontal: 3.87, vertikal: 1.56

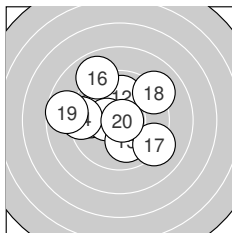

**Serie 2:**

9.7 ←	10.0 ↑	10.4 *	9.3 ←	10.0 ↓
8.9 ↘	9.2 ↘	9.1 ↗	8.7 ←	10.8 *

beste Teiler: 28.6 (20.), 134.1 (13.), 229.9 (15.)  
 Trefferlage: 0.79 mm links, 0.66 mm hoch  
 Streuwert: 2.66, horizontal: 3.07, vertikal: 2.18

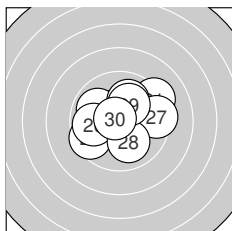

**Serie 3:**

9.2 ↗	10.2 *	9.9 ↘	10.0 ↗	9.5 ←
9.8 ←	9.4 →	10.0 ↓	10.2 *	10.7 *

beste Teiler: 56.4 (30.), 178.9 (22.), 199.2 (29.)  
 Trefferlage: 0.01 mm rechts, 0.48 mm hoch  
 Streuwert: 2.07, horizontal: 2.49, vertikal: 1.53

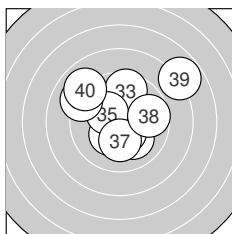

**Serie 4:**

10.1 ↘	10.3 *	9.6 ↑	10.5 *	10.3 *
9.1 ↘	10.2 *	9.7 →	7.8 ↗	9.0 ↘

beste Teiler: 120.5 (34.), 162.4 (32.), 162.4 (35.)  
 Trefferlage: 0.21 mm rechts, 0.94 mm hoch  
 Streuwert: 2.74, horizontal: 3.06, vertikal: 2.39



Ergebnis: **394.1** (375)  
 Serien: 98.0 98.0 100.0 98.1  
 Zähler: 18 19 3 0 0 0 0 0 0 0  
 Innenzehner: 10  
 Weitester: 665 (3.), 543 (34.), 524 (19.)  
 beste Teiler: 60.4 (6.), 81.9 (14.), 84.0 (22.)  
 Trefferlage: 0.94 mm rechts, 0.14 mm hoch  
 Streuwert: 2.07, horizontal: 2.19, vertikal: 1.95

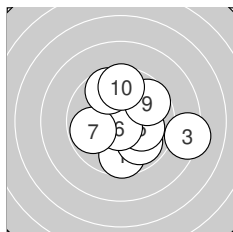
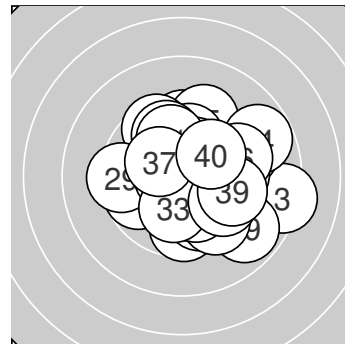

**Serie 1:**  
 9.6 ↓                      10.6 \*                      8.3 →                      9.9 ↘                      10.1 →  
 10.7 \*                      9.8 ←                      9.7 ↑                      9.7 ↗                      9.6 ↑  
 beste Teiler: 60.4 (6.), 94.5 (2.), 212.8 (5.)  
 Trefferlage: 0.99 mm rechts, 0.02 mm tief  
 Streuwert: 2.32, horizontal: 2.49, vertikal: 2.14

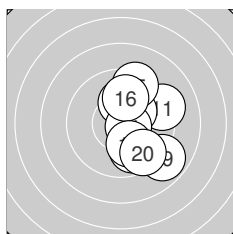

**Serie 2:**  
 9.2 →                      10.3 \*                      10.2 \*                      10.6 \*                      9.4 ↑  
 10.0 ↑                      9.8 ↘                      10.1 ↘                      8.9 ↘                      9.5 ↘  
 beste Teiler: 81.9 (14.), 172.0 (12.), 199.0 (13.)  
 Trefferlage: 1.61 mm rechts, 0.02 mm tief  
 Streuwert: 2.04, horizontal: 1.39, vertikal: 2.52

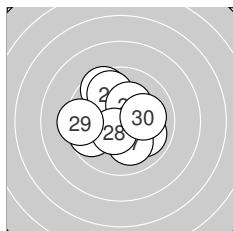

**Serie 3:**  
 9.6 ↘                      10.6 \*                      9.8 ↑                      9.9 ↘                      9.7 ←  
 10.3 \*                      10.1 ↘                      10.5 \*                      9.4 ←                      10.1 →  
 beste Teiler: 84.0 (22.), 116.8 (28.), 175.3 (26.)  
 Trefferlage: 0.46 mm links, 0.25 mm hoch  
 Streuwert: 1.88, horizontal: 2.03, vertikal: 1.71

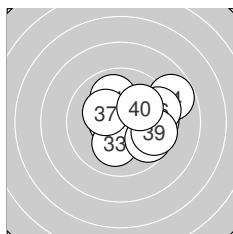

**Serie 4:**  
 10.0 ↑                      10.6 \*                      10.1 ↓                      8.8 →                      9.6 →  
 9.4 →                      10.3 \*                      9.7 ↘                      9.6 →                      10.0 ↗  
 beste Teiler: 85.0 (32.), 172.8 (37.), 211.0 (33.)  
 Trefferlage: 1.61 mm rechts, 0.37 mm hoch  
 Streuwert: 1.96, horizontal: 2.29, vertikal: 1.56







**Ergebnis:** **391.4** (376)  
**Serien:** 96.1 97.0 97.7 100.6  
**Zähler:** 21 15 3 1 0 0 0 0 0 0  
**Innenzehner:** 13  
**Weiteste:** 792 (10.), 668 (11.), 668 (21.)  
**beste Teiler:** 10.6 (6.), 40.2 (33.), 59.7 (29.)  
**Trefferlage:** 0.98 mm links, 0.84 mm hoch  
**Streuwert:** 2.28, horizontal: 2.63, vertikal: 1.85

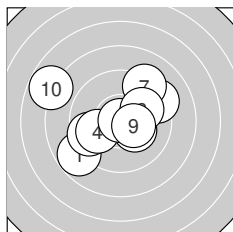
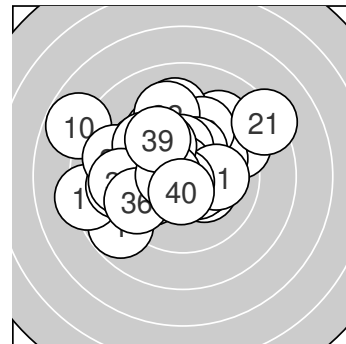

**Serie 1:**  
 8.8 ↙                      9.6 ↙                      10.3 \*                      9.9 ↙                      9.2 ↗  
 10.9 \*                      9.2 ↗                      10.0 ↗                      10.4 \*                      7.8 ↖  
**beste Teiler:** 10.6 (6.), 140.4 (9.), 172.0 (3.)  
**Trefferlage:** 0.58 mm links, 0.33 mm hoch  
**Streuwert:** 2.94, horizontal: 3.50, vertikal: 2.23

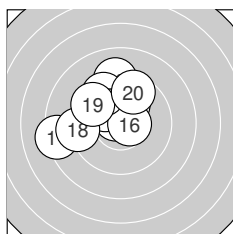

**Serie 2:**  
 8.3 ↙                      9.2 ↑                      10.7 \*                      10.1 ↘                      10.1 ↑  
 10.6 \*                      9.6 ↘                      9.2 ←                      9.6 ↘                      9.6 ↑  
**beste Teiler:** 66.0 (13.), 92.3 (16.), 206.3 (15.)  
**Trefferlage:** 1.51 mm links, 1.40 mm hoch  
**Streuwert:** 2.20, horizontal: 2.50, vertikal: 1.86

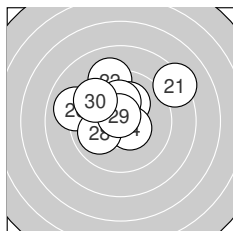

**Serie 3:**  
 8.3 ↗                      9.2 ↑                      10.2 \*                      10.5 \*                      10.0 ↖  
 9.0 ↖                      10.2 \*                      10.0 ↙                      10.7 \*                      9.6 ↖  
**beste Teiler:** 59.7 (29.), 118.6 (24.), 196.9 (23.)  
**Trefferlage:** 0.55 mm links, 1.51 mm hoch  
**Streuwert:** 2.28, horizontal: 2.75, vertikal: 1.69

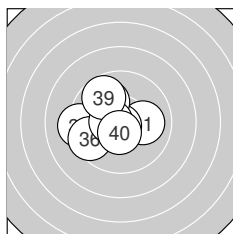

**Serie 4:**  
 10.0 →                      10.2 \*                      10.8 \*                      10.1 ↘                      9.3 ←  
 9.5 ↙                      10.0 ↘                      10.5 \*                      9.7 ↘                      10.5 \*  
**beste Teiler:** 40.2 (33.), 101.1 (38.), 107.6 (40.)  
**Trefferlage:** 1.29 mm links, 0.11 mm hoch  
**Streuwert:** 1.57, horizontal: 1.77, vertikal: 1.34



Ergebnis: **364.1** (347)  
 Serien: 88.1 97.5 94.8 83.7  
 Zähler: 15 8 7 9 1 0 0 0 0 0  
 Innenzehner: 11  
 Weitester: 1208 (38.), 958 (10.), 941 (36.)  
 beste Teiler: 49.2 (21.), 62.0 (15.), 82.3 (11.)  
 Trefferlage: 0.49 mm rechts, 1.59 mm tief  
 Streuwert: 3.82, horizontal: 3.39, vertikal: 4.21

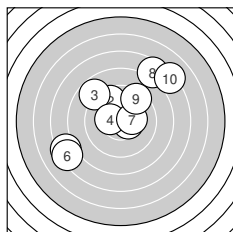
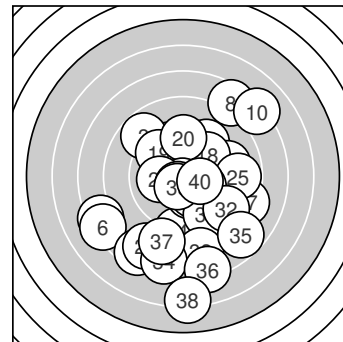

**Serie 1:**  
 10.5 \*                      9.6 ↘                      8.8 ↘                      10.3 \*                      7.3 ↙  
    7.3 ↙                      10.3 \*                      7.5 ↗                      9.4 ↗                      7.1 ↗  
 beste Teiler: 115.1 (1.), 156.7 (4.), 169.0 (7.)  
 Trefferlage: 0.57 mm links, 1.48 mm hoch  
 Streuwert: 4.53, horizontal: 4.99, vertikal: 4.02

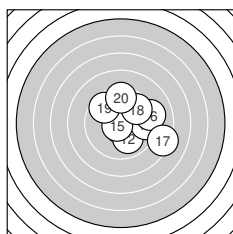

**Serie 2:**  
 10.6 \*                      10.0 ↘                      10.4 \*                      9.5 →                      10.7 \*  
    9.2 →                      8.3 →                      9.7 ↗                      9.6 ↘                      9.5 ↑  
 beste Teiler: 62.0 (15.), 82.3 (11.), 128.7 (13.)  
 Trefferlage: 1.42 mm rechts, 0.43 mm hoch  
 Streuwert: 2.35, horizontal: 2.64, vertikal: 2.01

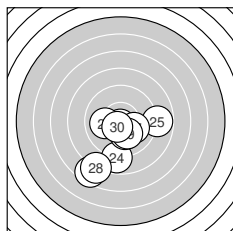

**Serie 3:**  
 10.8 \*                      7.5 ↙                      10.0 ←                      8.8 ↓                      8.8 →  
    10.2 \*                      10.1 →                      7.9 ↙                      10.1 ↘                      10.6 \*  
 beste Teiler: 49.2 (21.), 96.3 (30.), 200.1 (26.)  
 Trefferlage: 0.24 mm links, 2.58 mm tief  
 Streuwert: 2.82, horizontal: 2.83, vertikal: 2.82

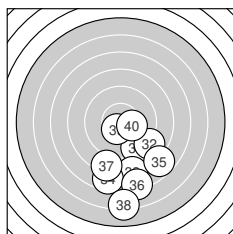

**Serie 4:**  
    9.2 ↘                      8.8 ↘                      8.0 ↓                      7.6 ↓                      7.7 ↘  
    7.2 ↓                      8.3 ↓                      6.1 ↓                      10.5 \*                      10.3 \*  
 beste Teiler: 115.8 (39.), 173.0 (40.), 435.4 (31.)  
 Trefferlage: 1.39 mm rechts, 5.71 mm tief  
 Streuwert: 3.13, horizontal: 2.48, vertikal: 3.67



Ergebnis: **385.8** (367)  
 Serien: 99.2 96.0 94.6 96.0  
 Zähler: 17 13 10 0 0 0 0 0 0 0  
 Innenzehner: 11  
 Weitester: 742 (40.), 706 (23.), 641 (14.)  
 beste Teiler: 37.1 (36.), 43.4 (24.), 86.7 (29.)  
 Trefferlage: 1.02 mm links, 0.16 mm hoch  
 Streuwert: 2.60, horizontal: 3.02, vertikal: 2.08

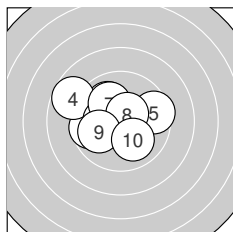
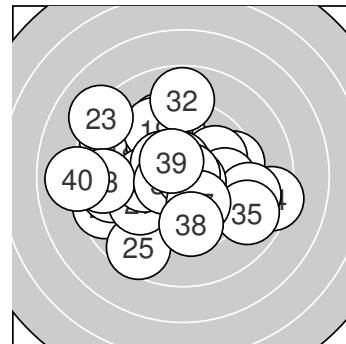

**Serie 1:**  
 10.4 \*                      9.7 ←                      10.0 ↘                      8.7 ↖                      9.5 →  
 10.3 \*                      10.1 ↘                      10.5 \*                      10.0 ←                      10.0 ↘  
 beste Teiler: 104.1 (8.), 140.0 (1.), 171.4 (6.)  
 Trefferlage: 0.82 mm links, 0.34 mm hoch  
 Streuwert: 2.04, horizontal: 2.47, vertikal: 1.48

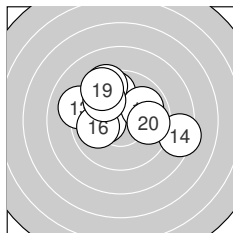

**Serie 2:**  
 10.3 \*                      9.8 ↑                      9.1 ↖                      8.4 →                      9.9 ↗  
 10.0 ←                      9.4 ↘                      9.9 ↘                      9.4 ↘                      9.8 →  
 beste Teiler: 167.9 (11.), 246.5 (16.), 260.6 (15.)  
 Trefferlage: 0.27 mm links, 1.17 mm hoch  
 Streuwert: 2.55, horizontal: 3.13, vertikal: 1.80

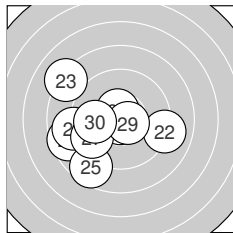

**Serie 3:**  
 8.6 ←                      9.0 →                      8.1 ↖                      10.8 \*                      8.6 ↙  
 8.9 ←                      9.5 ←                      10.6 \*                      10.6 \*                      9.9 ←  
 beste Teiler: 43.4 (24.), 86.7 (29.), 99.2 (28.)  
 Trefferlage: 1.99 mm links, 0.73 mm tief  
 Streuwert: 2.83, horizontal: 3.26, vertikal: 2.32

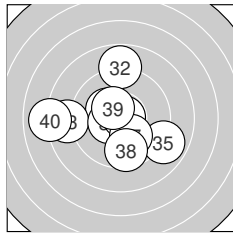

**Serie 4:**  
 10.3 \*                      8.8 ↑                      8.7 ←                      10.4 \*                      8.9 ↘  
 10.8 \*                      10.1 ↘                      9.6 ↓                      10.4 \*                      8.0 ←  
 beste Teiler: 37.1 (36.), 127.4 (34.), 132.8 (39.)  
 Trefferlage: 0.99 mm links, 0.13 mm tief  
 Streuwert: 2.93, horizontal: 3.38, vertikal: 2.40



**Ergebnis: 383.0 (367)**  
**Serien:** 95.9 97.0 95.6 94.5  
**Zähler:** 15 17 8 0 0 0 0 0 0 0  
**Innenzehner:** 12  
**Weiteste:** 705 (19.), 658 (32.), 619 (21.)  
**beste Teiler:** 55.3 (2.), 85.0 (38.), 135.2 (17.)  
**Trefferlage:** 1.29 mm rechts, 0.83 mm hoch  
**Streuwert:** 2.52, horizontal: 2.78, vertikal: 2.24

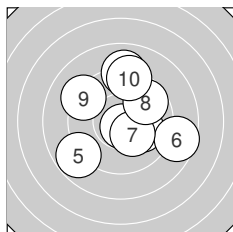
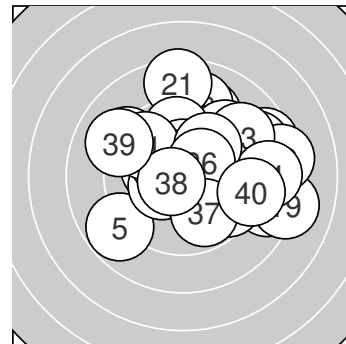

**Serie 1:**  
 10.4 \*                      10.7 \*                      10.0 ↘  
                                  8.6 ↘                      10.3 \*                      9.7 ↗  
**beste Teiler:** 55.3 (2.), 144.4 (1.), 171.8 (7.)  
**Trefferlage:** 0.60 mm rechts, 0.48 mm hoch  
**Streuwert:** 2.78, horizontal: 2.85, vertikal: 2.72

9.0 ↑                      8.8 ↖  
 9.2 ↘                      9.2 ↑

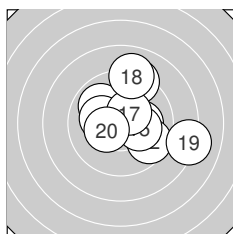

**Serie 2:**  
 10.1 →                      9.6 ↘                      9.2 ↑  
 10.2 \*                      10.4 \*                      9.0 ↑  
**beste Teiler:** 135.2 (17.), 153.0 (20.), 192.8 (15.)  
**Trefferlage:** 1.18 mm rechts, 0.72 mm hoch  
**Streuwert:** 2.44, horizontal: 2.61, vertikal: 2.25

9.9 ↘                      10.2 \*  
 8.1 →                      10.3 \*

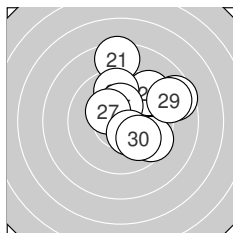

**Serie 3:**  
 8.5 ↑                      8.6 →                      9.4 ↗  
                                  9.6 ↘                      10.3 \*                      10.4 \*  
**beste Teiler:** 141.8 (28.), 153.0 (25.), 157.6 (27.)  
**Trefferlage:** 1.66 mm rechts, 1.42 mm hoch  
**Streuwert:** 2.39, horizontal: 2.30, vertikal: 2.47

9.7 ↑                      10.3 \*  
 8.8 →                      10.0 ↘

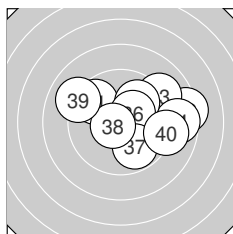

**Serie 4:**  
 9.7 ↘                      8.3 →                      9.1 ↗  
 10.3 \*                      9.8 ↘                      10.6 \*  
**beste Teiler:** 85.0 (38.), 151.4 (36.), 255.5 (35.)  
**Trefferlage:** 1.72 mm rechts, 0.71 mm hoch  
**Streuwert:** 2.73, horizontal: 3.50, vertikal: 1.63

8.7 →                      9.9 ↗  
 9.0 ↘                      9.1 →



Ergebnis: **377.4** (357)  
 Serien: 91.7 94.8 96.8 94.1  
 Zähler: 11 18 8 3 0 0 0 0 0 0  
 Innenzehner: 7  
 Weitester: 912 (9.), 833 (12.), 814 (18.)  
 beste Teiler: 68.3 (16.), 82.4 (14.), 82.8 (31.)  
 Trefferlage: 0.66 mm links, 0.69 mm hoch  
 Streuwert: 3.04, horizontal: 3.42, vertikal: 2.62

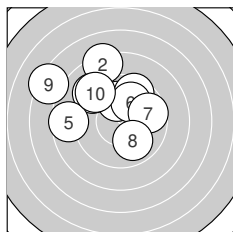
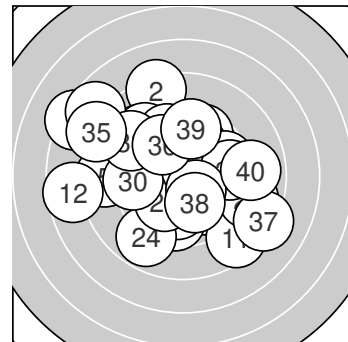

**Serie 1:**  
 10.0 ↑                      8.2 ↑                      9.6 ↑                      9.2 ↘                      8.6 ←  
 10.0 ↗                      9.7 →                      9.9 ↘                      7.3 ↘                      9.2 ↘  
 beste Teiler: 227.5 (1.), 243.8 (6.), 255.2 (8.)  
 Trefferlage: 1.52 mm links, 2.33 mm hoch  
 Streuwert: 3.02, horizontal: 3.56, vertikal: 2.38

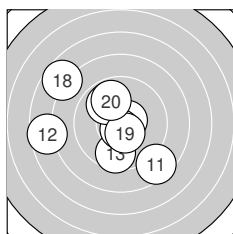

**Serie 2:**  
 8.5 ↘                      7.6 ←                      9.6 ↓                      10.6 \*                      9.9 ↘  
 10.7 \*                      9.9 ↘                      7.7 ↘                      10.5 \*                      9.8 ↗  
 beste Teiler: 68.3 (16.), 82.4 (14.), 120.4 (19.)  
 Trefferlage: 1.42 mm links, 0.12 mm hoch  
 Streuwert: 3.24, horizontal: 3.55, vertikal: 2.90

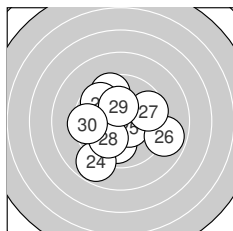

**Serie 3:**  
 9.9 ↓                      9.6 ↘                      9.7 ↘                      8.8 ↙                      10.5 \*  
 8.9 →                      9.6 →                      10.0 ↙                      10.3 \*                      9.5 ←  
 beste Teiler: 118.4 (25.), 168.7 (29.), 234.6 (28.)  
 Trefferlage: 0.30 mm links, 0.34 mm tief  
 Streuwert: 2.53, horizontal: 2.67, vertikal: 2.38

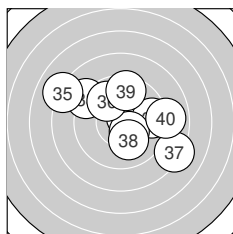

**Serie 4:**  
 10.6 \*                      9.5 →                      9.1 ↘                      10.4 \*                      8.0 ↘  
 9.8 ↘                      8.2 ↘                      10.1 ↓                      9.5 ↑                      8.9 →  
 beste Teiler: 82.8 (31.), 142.9 (34.), 217.9 (38.)  
 Trefferlage: 0.58 mm rechts, 0.68 mm hoch  
 Streuwert: 3.18, horizontal: 3.85, vertikal: 2.32



Ergebnis: **382.4** (365)  
 Serien: 96.5 94.4 94.8 96.7  
 Zähler: 14 19 5 2 0 0 0 0 0 0  
 Innenzehner: 10  
 Weitester: 978 (15.), 761 (22.), 647 (40.)  
 beste Teiler: 56.5 (37.), 75.9 (12.), 94.9 (27.)  
 Trefferlage: 0.25 mm links, 0.61 mm hoch  
 Streuwert: 2.83, horizontal: 2.88, vertikal: 2.77

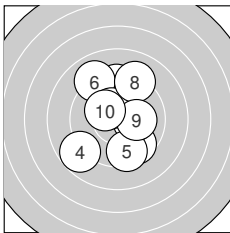
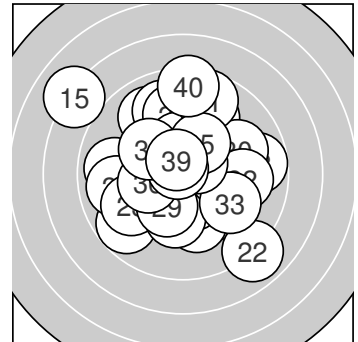

**Serie 1:**  
 9.6 ↘                      9.4 ↑                      10.3 \*                      8.8 ↙                      9.5 ↓  
 9.0 ↘                      10.4 \*                      9.1 ↗                      10.1 →                      10.3 \*  
 beste Teiler: 137.8 (7.), 169.4 (10.), 175.9 (3.)  
 Trefferlage: 0.00 mm , 0.41 mm hoch  
 Streuwert: 2.63, horizontal: 2.16, vertikal: 3.02

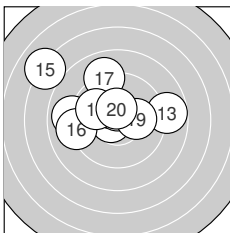

**Serie 2:**  
 8.9 ←                      10.7 \*                      8.8 →                      10.5 \*                      7.0 ↘  
 9.1 ←                      9.0 ↘                      9.9 ↘                      10.1 →                      10.4 \*  
 beste Teiler: 75.9 (12.), 107.0 (14.), 128.5 (20.)  
 Trefferlage: 1.47 mm links, 1.40 mm hoch  
 Streuwert: 3.07, horizontal: 3.79, vertikal: 2.11

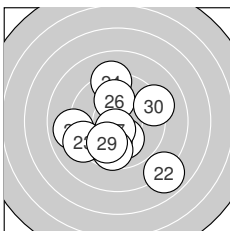

**Serie 3:**  
 9.0 ←                      7.9 ↘                      9.2 ↙                      9.2 ↑                      10.1 ↓  
 10.0 ↑                      10.6 \*                      9.7 ↓                      9.9 ↙                      9.2 →  
 beste Teiler: 94.9 (27.), 204.0 (25.), 233.4 (26.)  
 Trefferlage: 0.18 mm links, 0.87 mm tief  
 Streuwert: 2.98, horizontal: 3.03, vertikal: 2.93

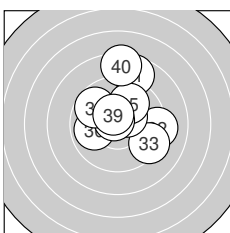

**Serie 4:**  
 8.7 ↗                      9.2 →                      9.3 ↘                      10.4 \*                      9.9 ↗  
 9.9 ←                      10.7 \*                      9.7 ↘                      10.5 \*                      8.4 ↑  
 beste Teiler: 56.5 (37.), 114.1 (39.), 131.0 (34.)  
 Trefferlage: 0.64 mm rechts, 1.51 mm hoch  
 Streuwert: 2.47, horizontal: 2.26, vertikal: 2.65



Ergebnis: **320.8** (302)  
 Serien: 81.9 79.4 76.4 83.1  
 Zähler: 2 10 10 11 5 0 1 0 0 1  
 Innenzehner: 2  
 Weitester: 2331 (26.), 1542 (9.), 1243 (13.)  
 beste Teiler: 105.6 (31.), 128.2 (25.), 285.2 (22.)  
 Trefferlage: 0.16 mm links, 1.95 mm hoch  
 Streuwert: 5.80, horizontal: 6.83, vertikal: 4.53

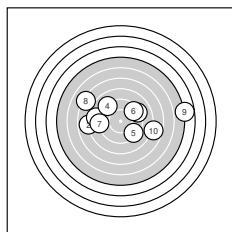
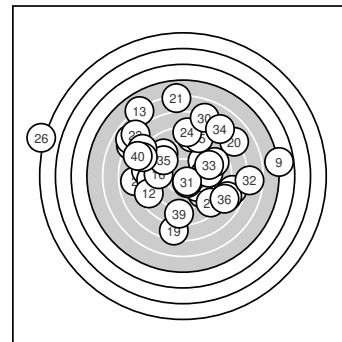

**Serie 1:**  
 9.1 ↗                      7.9 ←                      8.6 ←                      9.1 ↘                      9.3 ↘  
 9.4 ↗                      8.9 ←                      7.1 ↘                      4.8 →                      7.7 →  
 beste Teiler: 393.2 (6.), 414.2 (5.), 457.0 (1.)  
 Trefferlage: 0.34 mm rechts, 0.98 mm hoch  
 Streuwert: 5.68, horizontal: 7.64, vertikal: 2.50

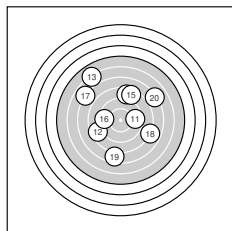

**Serie 2:**  
 9.6 →                      8.5 ←                      6.0 ↘                      8.4 ↑                      8.3 ↑  
 9.4 ←                      6.9 ↘                      7.9 ↘                      7.4 ↓                      7.0 ↗  
 beste Teiler: 350.3 (11.), 389.0 (16.), 607.7 (12.)  
 Trefferlage: 0.34 mm links, 1.98 mm hoch  
 Streuwert: 5.76, horizontal: 5.77, vertikal: 5.76

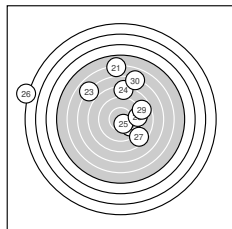

**Serie 3:**  
 6.0 ↑                      9.8 ↘                      6.9 ↘                      8.2 ↑                      10.4 \*  
 1.6 ↖                      8.5 ↘                      9.3 →                      8.7 →                      7.0 ↑  
 beste Teiler: 128.2 (25.), 285.2 (22.), 410.5 (28.)  
 Trefferlage: 1.05 mm links, 3.70 mm hoch  
 Streuwert: 7.03, horizontal: 8.38, vertikal: 5.36

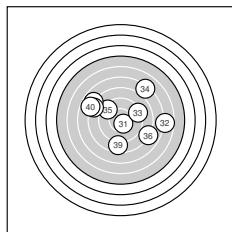

**Serie 4:**  
 10.5 \*                      6.7 →                      9.1 ↗                      7.1 ↗                      9.4 ↘  
 7.9 ↘                      7.9 ↘                      8.1 ↘                      8.6 ↓                      7.8 ↖  
 beste Teiler: 105.6 (31.), 397.8 (35.), 451.5 (33.)  
 Trefferlage: 0.41 mm rechts, 1.12 mm hoch  
 Streuwert: 5.21, horizontal: 6.23, vertikal: 3.95





Ergebnis: **362.5** (344)  
 Serien: 90.0 84.2 96.1 92.2  
 Zähler: 7 17 10 5 1 0 0 0 0 0  
 Innenzehner: 4  
 Weitester: 1017 (35.), 868 (17.), 853 (16.)  
 beste Teiler: 47.0 (29.), 75.3 (25.), 194.8 (32.)  
 Trefferlage: 1.01 mm rechts, 1.06 mm hoch  
 Streuwert: 3.65, horizontal: 3.77, vertikal: 3.52

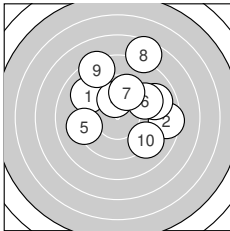
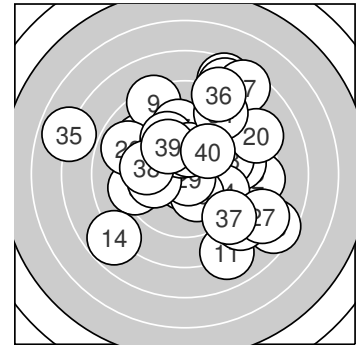

**Serie 1:**

9.1 ↘	8.5 →	9.0 →	10.1 ↑	9.2 ←
9.4 ↗	9.6 ↗	7.6 ↗	8.4 ↘	9.1 ↘

beste Teiler: 224.5 (4.), 329.9 (7.), 396.3 (6.)  
 Trefferlage: 1.13 mm rechts, 2.14 mm hoch  
 Streuwert: 3.40, horizontal: 3.63, vertikal: 3.16

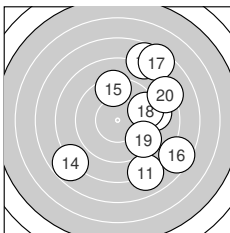

**Serie 2:**

8.0 ↘	9.1 →	7.7 ↗	7.8 ↙	9.4 ↑
7.5 ↘	7.5 ↗	9.5 →	9.4 ↘	8.3 ↗

beste Teiler: 370.0 (18.), 399.0 (19.), 399.6 (15.)  
 Trefferlage: 2.96 mm rechts, 0.54 mm hoch  
 Streuwert: 4.42, horizontal: 3.73, vertikal: 5.01

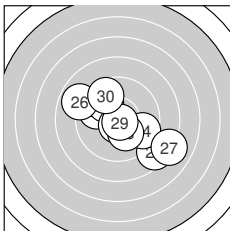

**Serie 3:**

9.8 ↘	8.5 ↘	10.0 ↘	9.6 ↘	10.7 *
8.9 ↘	8.0 ↘	10.2 *	10.8 *	9.6 ↘

beste Teiler: 47.0 (29.), 75.3 (25.), 195.8 (28.)  
 Trefferlage: 0.49 mm rechts, 0.38 mm tief  
 Streuwert: 2.93, horizontal: 3.40, vertikal: 2.37

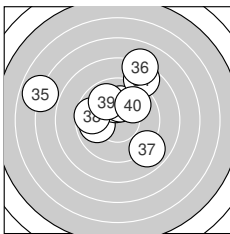

**Serie 4:**

9.9 ←	10.2 *	10.1 ↑	8.6 ↗	6.9 ↘
8.1 ↗	8.9 ↘	9.7 ←	9.9 ↘	9.9 ↗

beste Teiler: 194.8 (32.), 204.6 (33.), 260.8 (31.)  
 Trefferlage: 0.53 mm links, 1.95 mm hoch  
 Streuwert: 3.45, horizontal: 3.97, vertikal: 2.83



Ergebnis: **375.4** (357)  
 Serien: 92.2 92.9 93.8 96.5  
 Zähler: 10 20 7 3 0 0 0 0 0 0  
 Innenzehner: 6  
 Weiteste: 860 (1.), 816 (24.), 776 (14.)  
 beste Teiler: 116.7 (3.), 123.4 (27.), 155.5 (19.)  
 Trefferlage: 1.12 mm links, 1.02 mm hoch  
 Streuwert: 2.91, horizontal: 3.40, vertikal: 2.32

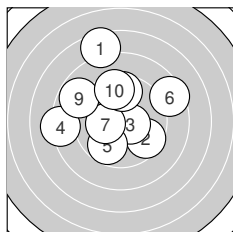
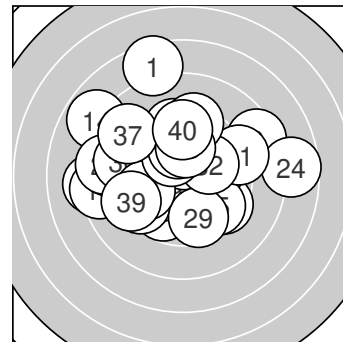

**Serie 1:**  
 7.5 ↑                      9.6 ↘                      10.5 \*                      8.2 ←                      9.7 ↙  
 8.5 →                      10.3 \*                      9.6 ↑                      8.8 ↖                      9.5 ↑  
 beste Teiler: 116.7 (3.), 173.1 (7.), 301.7 (5.)  
 Trefferlage: 0.79 mm links, 1.49 mm hoch  
 Streuwert: 3.41, horizontal: 3.54, vertikal: 3.28

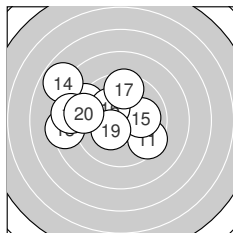

**Serie 2:**  
 9.5 ↘                      9.2 ↖                      8.4 ←                      7.8 ↖                      10.0 →  
 10.2 \*                      9.5 ↑                      8.7 ←                      10.3 \*                      9.3 ←  
 beste Teiler: 155.5 (19.), 182.8 (16.), 230.9 (15.)  
 Trefferlage: 2.31 mm links, 0.87 mm hoch  
 Streuwert: 2.85, horizontal: 3.50, vertikal: 2.01

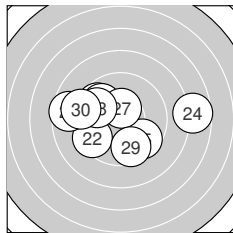

**Serie 3:**  
 9.7 ↖                      9.4 ↙                      8.6 ←                      7.7 →                      9.6 ↘  
 9.8 ↖                      10.5 \*                      9.8 ↖                      9.6 ↓                      9.1 ←  
 beste Teiler: 123.4 (27.), 278.4 (26.), 296.5 (28.)  
 Trefferlage: 0.91 mm links, 0.14 mm hoch  
 Streuwert: 3.16, horizontal: 4.06, vertikal: 1.86

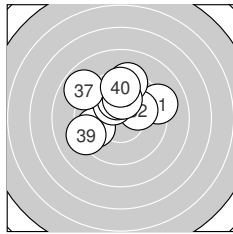

**Serie 4:**  
 9.2 →                      10.1 →                      9.7 ←                      9.3 ↑                      10.3 \*  
 10.1 ↑                      8.9 ↖                      10.1 ↑                      9.2 ←                      9.6 ↑  
 beste Teiler: 170.6 (35.), 209.6 (36.), 213.8 (38.)  
 Trefferlage: 0.49 mm links, 1.58 mm hoch  
 Streuwert: 2.28, horizontal: 2.60, vertikal: 1.89



Ergebnis: **354.7** (340)  
 Serien: 87.9 83.9 96.3 86.6  
 Zähler: 13 10 11 4 0 0 1 0 0 0  
 Innenzehner: 8  
 Weitester: 2592 (20.), 1623 (37.), 990 (2.)  
 beste Teiler: 56.6 (32.), 84.3 (23.), 133.8 (29.)  
 Trefferlage: 0.91 mm rechts, 1.00 mm hoch  
 Streuwert: 4.77, horizontal: 5.09, vertikal: 4.43

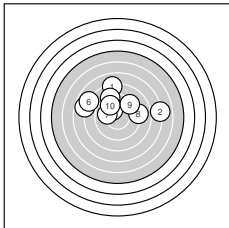
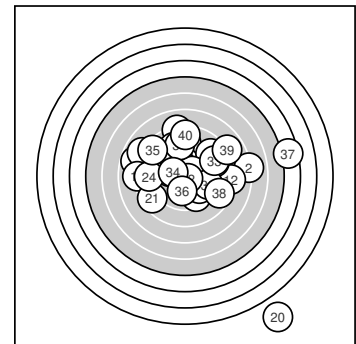

**Serie 1:**

8.1 ↑                      7.0 →                      9.0 ↗                      7.8 ←                      10.2 \*  
 7.9 ↘                      10.0 ←                      9.0 →                      9.3 ↗                      9.6 ↘

beste Teiler: 193.3 (5.), 247.5 (7.), 326.0 (10.)  
 Trefferlage: 0.49 mm links, 2.76 mm hoch  
 Streuwert: 3.91, horizontal: 5.17, vertikal: 1.95

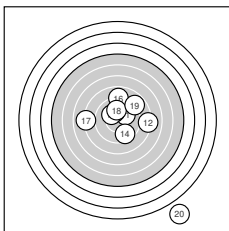

**Serie 2:**

10.1 ↗                      8.1 →                      10.2 \*                      9.5 ↘                      10.2 \*  
 8.9 ↑                      8.0 ←                      10.0 ↑                      8.9 ↗                      0.0 ↘

beste Teiler: 189.8 (15.), 192.3 (13.), 214.9 (11.)  
 Trefferlage: 1.92 mm rechts, 1.01 mm tief  
 Streuwert: 6.72, horizontal: 5.71, vertikal: 7.59

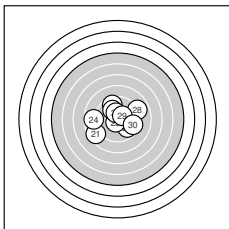

**Serie 3:**

8.5 ↙                      9.8 ↘                      10.6 \*                      8.7 ←                      9.6 ↗  
 10.0 ↘                      10.3 \*                      9.0 ↗                      10.4 \*                      9.4 ↗

beste Teiler: 84.3 (23.), 133.8 (29.), 153.5 (27.)  
 Trefferlage: 0.24 mm links, 0.24 mm hoch  
 Streuwert: 2.75, horizontal: 3.29, vertikal: 2.08

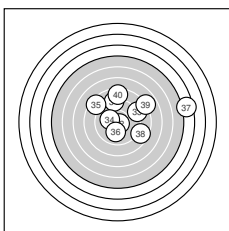

**Serie 4:**

9.0 ↑                      10.7 \*                      8.9 ↗                      10.2 \*                      8.4 ↘  
 10.0 ↓                      4.5 →                      8.6 ↘                      7.9 ↗                      8.4 ↑

beste Teiler: 56.6 (32.), 190.3 (34.), 231.2 (36.)  
 Trefferlage: 2.46 mm rechts, 2.04 mm hoch  
 Streuwert: 4.68, horizontal: 5.87, vertikal: 3.06



Ergebnis: **318.1** (299)  
 Serien: 81.5 68.3 83.8 84.5  
 Zähler: 5 10 8 5 6 2 3 0 1 0  
 Innenzehner: 3  
 Weitester: 2240 (18.), 1712 (2.), 1662 (17.)  
 beste Teiler: 28.0 (39.), 115.5 (23.), 185.8 (31.)  
 Trefferlage: 0.02 mm rechts, 1.55 mm tief  
 Streuwert: 6.28, horizontal: 7.70, vertikal: 4.43

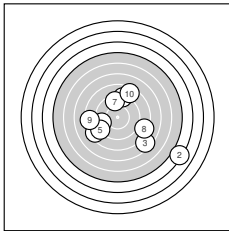
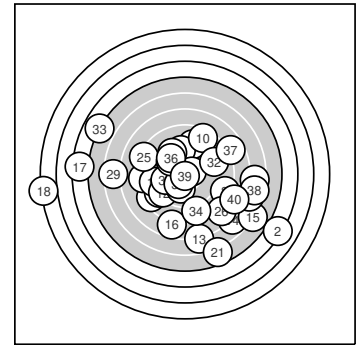

**Serie 1:**

8.4 ↙	4.1 ↘	7.4 ↘	9.4 ↙	8.9 ↙
9.0 ↑	9.4 ↑	8.2 ↘	8.3 ↙	8.4 ↑

beste Teiler: 383.3 (7.), 395.2 (4.), 483.6 (6.)  
 Trefferlage: 1.10 mm rechts, 1.19 mm tief  
 Streuwert: 5.76, horizontal: 6.63, vertikal: 4.73

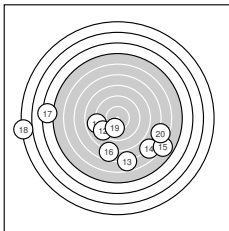

**Serie 2:**

8.9 ↙	9.2 ↙	6.8 ↓	6.8 ↘	5.9 ↘
7.7 ↓	4.3 ←	2.0 ←	10.0 ↓	6.7 ↘

beste Teiler: 237.6 (19.), 449.4 (12.), 503.9 (11.)  
 Trefferlage: 1.94 mm links, 4.33 mm tief  
 Streuwert: 8.03, horizontal: 10.80, vertikal: 3.50

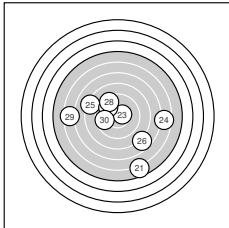

**Serie 3:**

5.6 ↓	10.1 ↖	10.5 *	6.6 →	8.1 ↖
7.7 ↘	9.7 ↖	9.4 ↖	6.4 ←	9.7 ←

beste Teiler: 115.5 (23.), 225.6 (22.), 301.4 (27.)  
 Trefferlage: 0.41 mm links, 1.04 mm tief  
 Streuwert: 5.63, horizontal: 6.42, vertikal: 4.70

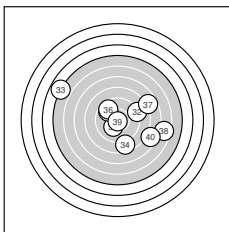

**Serie 4:**

10.2 *	9.0 →	4.9 ↖	8.5 ↓	9.8 ↖
9.6 ↖	7.7 →	6.5 →	10.8 *	7.5 ↘

beste Teiler: 28.0 (39.), 185.8 (31.), 298.7 (35.)  
 Trefferlage: 1.34 mm rechts, 0.33 mm hoch  
 Streuwert: 5.61, horizontal: 6.90, vertikal: 3.90



Ergebnis: **391.6** (373)  
 Serien: 96.6 97.7 98.5 98.8  
 Zähler: 18 17 5 0 0 0 0 0 0 0  
 Innenzehner: 14  
 Weitester: 742 (17.), 650 (29.), 638 (11.)  
 beste Teiler: 1.4 (30.), 77.8 (8.), 79.0 (33.)  
 Trefferlage: 0.73 mm rechts, 0.37 mm hoch  
 Streuwert: 2.32, horizontal: 2.57, vertikal: 2.04

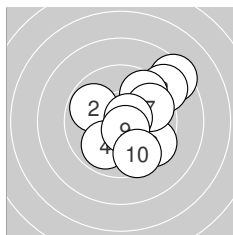
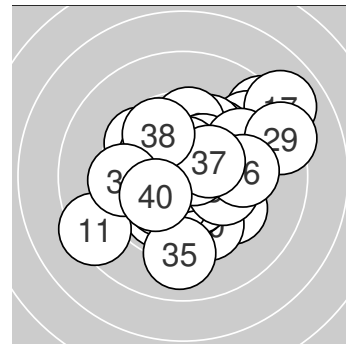

**Serie 1:**  
 8.4 ↗ 9.8 ↘ 8.9 ↗ 9.9 ↘ 9.6 ↗  
 9.5 ↘ 9.7 ↗ 10.6 \* 10.6 \* 9.6 ↘  
 beste Teiler: 77.8 (8.), 90.0 (9.), 261.8 (4.)  
 Trefferlage: 1.55 mm rechts, 0.44 mm hoch  
 Streuwert: 2.35, horizontal: 2.31, vertikal: 2.39

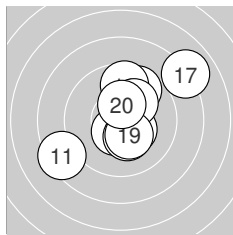

**Serie 2:**  
 8.4 ↙ 10.5 \* 9.7 ↗ 10.3 \* 10.4 \*  
 9.6 ↑ 8.0 ↗ 10.1 ↗ 10.3 \* 10.4 \*  
 beste Teiler: 114.5 (12.), 143.6 (15.), 147.4 (20.)  
 Trefferlage: 0.59 mm rechts, 0.54 mm hoch  
 Streuwert: 2.64, horizontal: 2.78, vertikal: 2.49

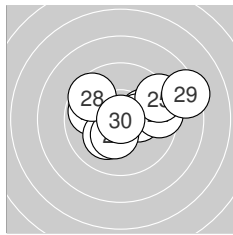

**Serie 3:**  
 10.1 → 10.3 \* 9.9 ↖ 9.5 → 9.3 ↗  
 10.2 \* 10.3 \* 9.6 ↘ 8.4 → 10.9 \*  
 beste Teiler: 1.4 (30.), 155.8 (27.), 164.4 (22.)  
 Trefferlage: 0.98 mm rechts, 0.53 mm hoch  
 Streuwert: 2.26, horizontal: 2.91, vertikal: 1.34

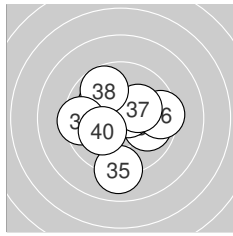

**Serie 4:**  
 10.2 \* 9.9 ↘ 10.6 \* 10.1 ↘ 9.0 ↓  
 9.5 → 10.2 \* 9.7 ↘ 9.5 ← 10.1 ↙  
 beste Teiler: 79.0 (33.), 185.8 (37.), 189.4 (31.)  
 Trefferlage: 0.18 mm links, 0.02 mm tief  
 Streuwert: 2.15, horizontal: 2.28, vertikal: 2.00



Ergebnis: **331.4** (315)  
 Serien: 74.7 86.1 83.1 87.5  
 Zähler: 5 9 15 6 1 1 2 1 0 0  
 Innenzehner: 4  
 Weitester: 1805 (30.), 1661 (2.), 1540 (8.)  
 beste Teiler: 106.7 (7.), 113.6 (24.), 115.1 (35.)  
 Trefferlage: 2.29 mm rechts, 2.00 mm tief  
 Streuwert: 5.08, horizontal: 6.13, vertikal: 3.76

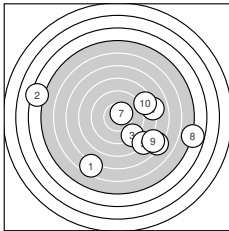
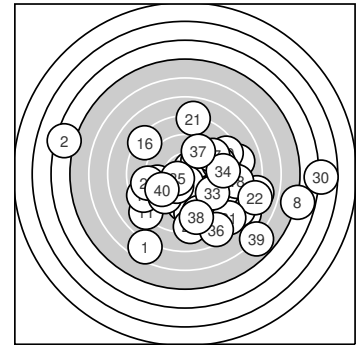

**Serie 1:**

6.6 ↙	4.3 ←	9.1 ↘	8.1 →	8.1 ↘
7.2 ↘	10.5 *	4.8 →	7.5 ↘	8.5 ↘

beste Teiler: 106.7 (7.), 465.2 (3.), 614.0 (10.)  
 Trefferlage: 2.98 mm rechts, 2.23 mm tief  
 Streuwert: 6.76, horizontal: 8.46, vertikal: 4.43

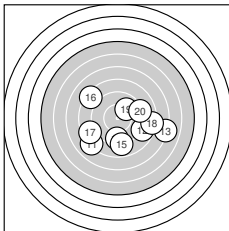

**Serie 2:**

8.1 ↙	8.8 ↘	7.0 →	9.3 ↓	8.9 ↓
8.2 ↘	8.5 ←	8.2 →	10.0 ↗	9.1 →

beste Teiler: 247.5 (19.), 401.2 (14.), 468.9 (20.)  
 Trefferlage: 1.21 mm rechts, 1.53 mm tief  
 Streuwert: 4.37, horizontal: 5.34, vertikal: 3.12

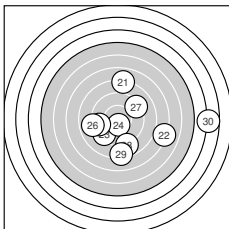

**Serie 3:**

8.0 ↑	7.0 →	9.4 ↙	10.5 *	9.4 ←
8.9 ←	9.2 ↗	8.8 ↓	8.2 ↓	3.7 →

beste Teiler: 113.6 (24.), 380.0 (25.), 398.7 (23.)  
 Trefferlage: 2.36 mm rechts, 1.20 mm tief  
 Streuwert: 5.59, horizontal: 6.83, vertikal: 3.99

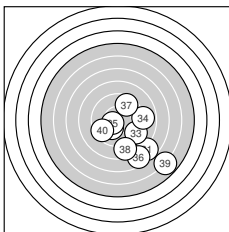

**Serie 4:**

7.7 ↘	10.2 *	9.2 ↘	8.9 →	10.5 *
7.6 ↘	9.5 ↗	8.6 ↓	5.8 ↘	9.5 ←

beste Teiler: 115.1 (35.), 195.5 (32.), 351.7 (37.)  
 Trefferlage: 2.63 mm rechts, 3.06 mm tief  
 Streuwert: 3.73, horizontal: 3.77, vertikal: 3.69



Ergebnis: **360.0** (343)  
 Serien: 87.8 88.4 94.9 88.9  
 Zähler: 7 16 12 3 2 0 0 0 0 0  
 Innenzehner: 5  
 Weitester: 1127 (37.), 1104 (7.), 875 (14.)  
 beste Teiler: 65.1 (8.), 70.4 (29.), 74.4 (25.)  
 Trefferlage: 0.52 mm rechts, 0.36 mm hoch  
 Streuwert: 3.91, horizontal: 4.91, vertikal: 2.54

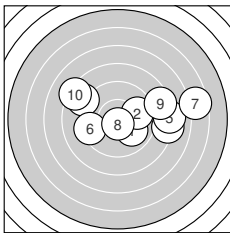
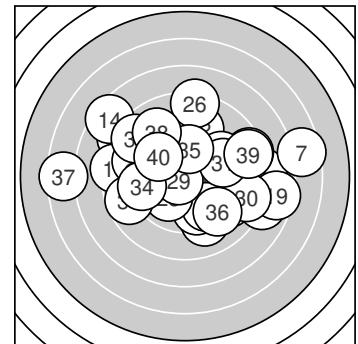

**Serie 1:**

10.0 ↘	9.8 →	8.7 ↖	8.1 →	8.1 →
9.3 ←	6.5 →	10.7 *	8.4 →	8.2 ↖

beste Teiler: 65.1 (8.), 246.2 (1.), 285.9 (2.)  
 Trefferlage: 2.11 mm rechts, 0.73 mm hoch  
 Streuwert: 4.24, horizontal: 5.70, vertikal: 1.84

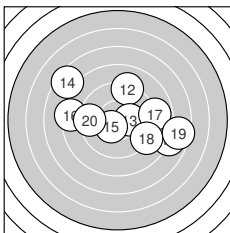

**Serie 2:**

7.9 ↘	9.1 ↑	10.3 *	7.5 ↖	10.4 *
8.3 ←	8.9 →	9.1 ↘	7.5 →	9.4 ←

beste Teiler: 126.5 (15.), 168.0 (13.), 389.0 (20.)  
 Trefferlage: 0.95 mm rechts, 0.33 mm hoch  
 Streuwert: 4.30, horizontal: 5.46, vertikal: 2.68

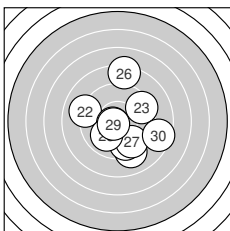

**Serie 3:**

9.1 ↓	9.1 ↖	9.4 →	9.6 ↓	10.7 *
8.2 ↑	9.6 ↓	10.0 ↙	10.7 *	8.5 →

beste Teiler: 70.4 (29.), 74.4 (25.), 245.5 (28.)  
 Trefferlage: 0.75 mm rechts, 0.48 mm tief  
 Streuwert: 3.01, horizontal: 2.80, vertikal: 3.21

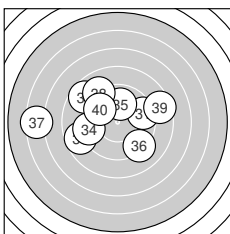

**Serie 4:**

9.5 →	8.7 ↖	8.7 ←	9.3 ←	9.9 ↑
9.2 ↘	6.4 ←	9.0 ↖	8.5 →	9.7 ↖

beste Teiler: 253.0 (35.), 305.0 (40.), 375.0 (31.)  
 Trefferlage: 1.72 mm links, 0.86 mm hoch  
 Streuwert: 3.96, horizontal: 5.06, vertikal: 2.42



Ergebnis: **346.8** (328)  
 Serien: 86.2 87.8 84.0 88.8  
 Zähler: 7 14 8 7 0 3 1 0 0 0  
 Innenzehner: 2  
 Weitester: 1675 (21.), 1453 (18.), 1354 (30.)  
 beste Teiler: 131.1 (28.), 178.8 (26.), 212.0 (35.)  
 Trefferlage: 0.91 mm links, 1.81 mm hoch  
 Streuwert: 4.63, horizontal: 5.70, vertikal: 3.21

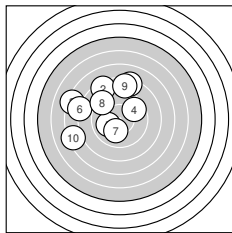
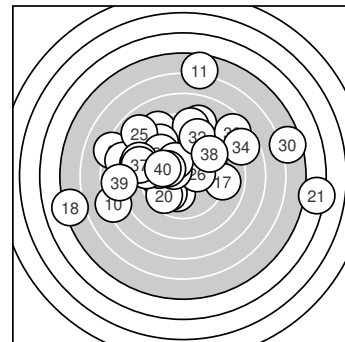

**Serie 1:**  
 8.2 ↑                      8.3 ↘                      7.2 ←                      9.7 ↗                      10.0 ←  
 7.9 ←                      10.1 ↓                      9.2 ↘                      8.4 ↑                      7.2 ←  
 beste Teiler: 224.5 (7.), 234.0 (5.), 325.6 (4.)  
 Trefferlage: 2.84 mm links, 2.19 mm hoch  
 Streuwert: 3.90, horizontal: 4.26, vertikal: 3.50

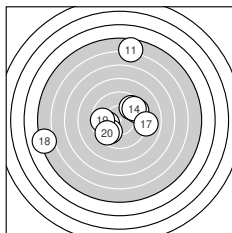

**Serie 2:**  
 5.7 ↑                      9.7 ↗                      9.5 ↗                      9.6 ↗                      10.0 ←  
 9.9 ↘                      9.0 →                      5.1 ←                      9.7 ←                      9.6 ↘  
 beste Teiler: 234.8 (15.), 274.8 (16.), 317.7 (12.)  
 Trefferlage: 0.85 mm links, 0.96 mm hoch  
 Streuwert: 5.08, horizontal: 5.40, vertikal: 4.73

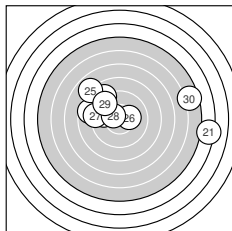

**Serie 3:**  
 4.3 →                      9.7 ←                      8.6 ←                      8.9 ↘                      7.9 ↘  
 10.2 \*                      9.1 ←                      10.4 \*                      9.4 ↘                      5.5 →  
 beste Teiler: 131.1 (28.), 178.8 (26.), 304.6 (22.)  
 Trefferlage: 0.61 mm rechts, 1.77 mm hoch  
 Streuwert: 5.75, horizontal: 7.81, vertikal: 2.30

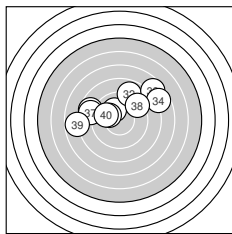

**Serie 4:**  
 10.1 ↘                      8.9 ↑                      7.7 ↗                      7.7 ↗                      10.1 ↘  
 8.7 ←                      8.7 ←                      9.2 ↗                      7.8 ←                      9.9 ←  
 beste Teiler: 212.0 (35.), 212.4 (31.), 267.4 (40.)  
 Trefferlage: 0.55 mm links, 2.30 mm hoch  
 Streuwert: 3.84, horizontal: 5.08, vertikal: 1.92





**Ergebnis:** **344.9** (327)  
**Serien:** 88.8 83.9 87.9 84.3  
**Zähler:** 4 18 7 5 4 2 0 0 0 0  
**Innenzehner:** 0  
**Weiteste:** 1324 (30.), 1275 (13.), 1097 (3.)  
**beste Teiler:** 223.0 (38.), 238.4 (9.), 239.7 (23.)  
**Trefferlage:** 1.89 mm links, 0.50 mm tief  
**Streuwert:** 4.44, horizontal: 5.30, vertikal: 3.37

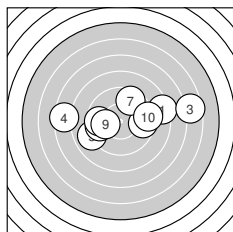
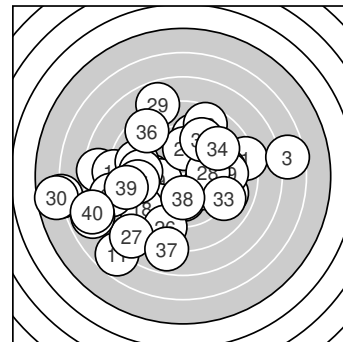

**Serie 1:**  
 8.3 →                      9.6 →                      6.6 →                      7.4 ←                      9.0 ←  
 9.6 ←                      9.5 ↑                      9.6 ←                      10.0 ←                      9.2 →

**beste Teiler:** 238.4 (9.), 332.5 (6.), 335.0 (8.)  
**Trefferlage:** 0.44 mm rechts, 0.45 mm hoch  
**Streuwert:** 4.31, horizontal: 5.89, vertikal: 1.56

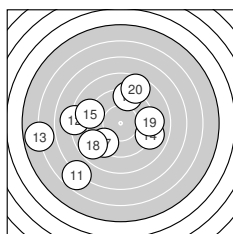

**Serie 2:**  
 6.7 ↙                      8.1 ←                      5.9 ←                      9.0 →                      9.0 ←  
 9.2 ↑                      9.4 ↙                      8.8 ↙                      9.2 →                      8.6 ↑

**beste Teiler:** 395.2 (17.), 431.9 (16.), 450.8 (19.)  
**Trefferlage:** 2.56 mm links, 0.64 mm tief  
**Streuwert:** 4.83, horizontal: 5.62, vertikal: 3.89

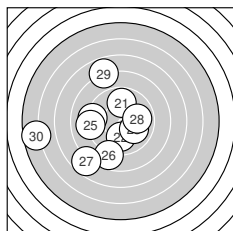

**Serie 3:**  
 9.8 ↑                      10.0 ↓                      10.0 ↘                      9.2 ←                      9.1 ←  
 8.7 ↓                      7.7 ↙                      9.9 →                      7.8 ↑                      5.7 ←

**beste Teiler:** 239.7 (23.), 241.0 (22.), 260.0 (28.)  
**Trefferlage:** 2.70 mm links, 0.67 mm tief  
**Streuwert:** 4.25, horizontal: 4.57, vertikal: 3.90

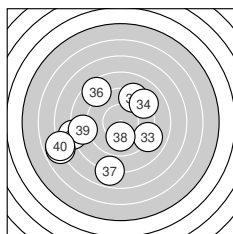

**Serie 4:**  
 9.3 ↗                      7.9 ←                      9.0 ↘                      9.1 ↗                      6.9 ←  
 8.6 ↘                      7.9 ↓                      10.1 ↓                      8.6 ←                      6.9 ←

**beste Teiler:** 223.0 (38.), 423.9 (31.), 458.9 (34.)  
**Trefferlage:** 2.76 mm links, 1.17 mm tief  
**Streuwert:** 4.55, horizontal: 5.15, vertikal: 3.85



Ergebnis: **357.1** (339)  
 Serien: 91.3 92.1 93.2 80.5  
 Zähler: 6 15 14 2 3 0 0 0 0 0  
 Innenzehner: 5  
 Weitester: 1178 (31.), 1175 (35.), 1095 (33.)  
 beste Teiler: 46.6 (26.), 100.0 (13.), 134.7 (32.)  
 Trefferlage: 0.11 mm rechts, 0.83 mm hoch  
 Streuwert: 4.03, horizontal: 4.89, vertikal: 2.93

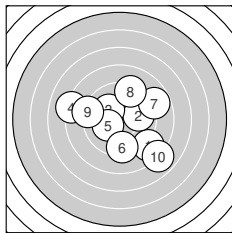
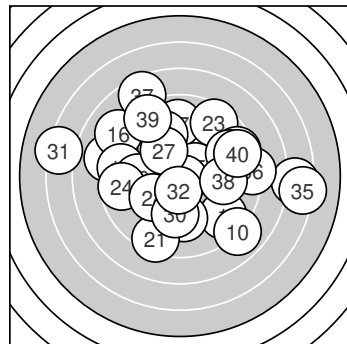

**Serie 1:**

8.7 ↘	9.8 →	10.1 ↘	8.1 ←	10.2 *
9.4 ↓	8.8 ↗	9.2 ↑	9.1 ←	7.9 ↘

beste Teiler: 188.3 (5.), 204.1 (3.), 276.7 (2.)  
 Trefferlage: 0.45 mm rechts, 0.29 mm tief  
 Streuwert: 3.63, horizontal: 4.11, vertikal: 3.07

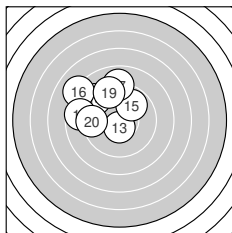

**Serie 2:**

9.0 ←	9.1 ←	10.6 *	9.1 ↘	9.9 ↗
8.1 ↘	8.9 ↑	8.7 ←	9.3 ↑	9.4 ←

beste Teiler: 100.0 (13.), 274.0 (15.), 399.2 (20.)  
 Trefferlage: 2.81 mm links, 2.02 mm hoch  
 Streuwert: 2.31, horizontal: 2.62, vertikal: 1.96

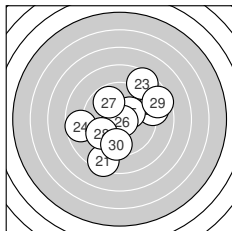

**Serie 3:**

8.4 ↓	9.0 →	8.5 ↗	8.7 ←	10.3 *
10.8 *	9.8 ↘	9.6 ↙	8.6 ↗	9.5 ↓

beste Teiler: 46.6 (26.), 169.1 (25.), 285.7 (27.)  
 Trefferlage: 0.28 mm rechts, 0.06 mm tief  
 Streuwert: 3.35, horizontal: 3.48, vertikal: 3.22

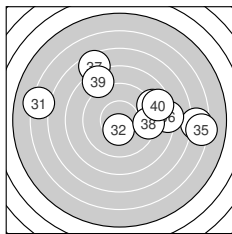

**Serie 4:**

6.2 ←	10.4 *	6.6 →	8.9 ↗	6.3 →
8.2 →	7.6 ↘	9.3 →	8.4 ↘	8.6 →

beste Teiler: 134.7 (32.), 416.3 (38.), 515.9 (34.)  
 Trefferlage: 2.54 mm rechts, 1.67 mm hoch  
 Streuwert: 5.50, horizontal: 7.17, vertikal: 2.99



Ergebnis: **377.9** (357)  
 Serien: 97.0 93.9 90.9 96.1  
 Zähler: 9 20 10 1 0 0 0 0 0 0  
 Innenzehner: 8  
 Weitesten: 805 (23.), 711 (17.), 703 (10.)  
 beste Teiler: 23.1 (39.), 92.2 (9.), 146.1 (6.)  
 Trefferlage: 0.59 mm links, 1.45 mm hoch  
 Streuwert: 2.79, horizontal: 3.32, vertikal: 2.14

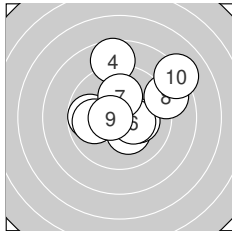
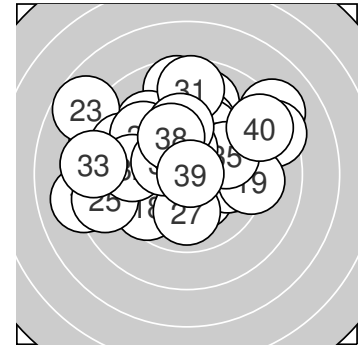

**Serie 1:**

10.3 *	9.8 ←	9.9 ←	8.7 ↑	10.2 *
10.4 *	10.1 ↑	8.9 ↗	10.6 *	8.1 ↘

beste Teiler: 92.2 (9.), 146.1 (6.), 171.6 (1.)  
 Trefferlage: 0.74 mm rechts, 1.13 mm hoch  
 Streuwert: 2.58, horizontal: 2.82, vertikal: 2.32

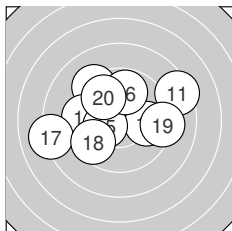

**Serie 2:**

8.4 ↗	9.9 →	9.3 ↘	9.5 ←	10.3 *
9.8 ↑	8.1 ←	9.6 ↙	9.2 →	9.8 ↘

beste Teiler: 156.7 (15.), 274.2 (12.), 282.1 (20.)  
 Trefferlage: 0.54 mm links, 0.63 mm hoch  
 Streuwert: 3.09, horizontal: 3.89, vertikal: 2.00

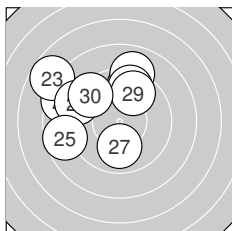

**Serie 3:**

8.5 ↖	9.4 ↑	7.7 ↘	9.1 ↖	8.7 ←
9.0 ↑	9.9 ↓	9.5 ↑	9.7 ↑	9.4 ↘

beste Teiler: 251.0 (27.), 311.7 (29.), 355.4 (28.)  
 Trefferlage: 2.05 mm links, 2.13 mm hoch  
 Streuwert: 2.90, horizontal: 3.32, vertikal: 2.41

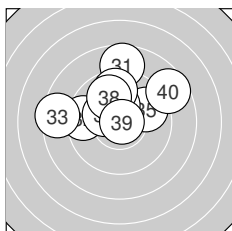

**Serie 4:**

8.7 ↑	9.5 ←	8.4 ←	10.3 *	9.8 ↗
10.3 *	9.7 ↑	9.9 ↘	10.9 *	8.6 ↗

beste Teiler: 23.1 (39.), 170.0 (36.), 170.8 (34.)  
 Trefferlage: 0.51 mm links, 1.93 mm hoch  
 Streuwert: 2.49, horizontal: 3.07, vertikal: 1.72



Ergebnis: **361.0** (342)  
 Serien: 92.2 88.2 90.9 89.7  
 Zähler: 5 18 12 4 1 0 0 0 0 0  
 Innenzehner: 3  
 Weitester: 1004 (22.), 976 (17.), 966 (38.)  
 beste Teiler: 86.4 (11.), 161.1 (27.), 179.2 (9.)  
 Trefferlage: 0.48 mm rechts, 1.54 mm hoch  
 Streuwert: 3.64, horizontal: 4.34, vertikal: 2.77

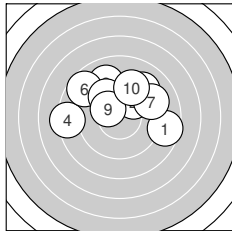
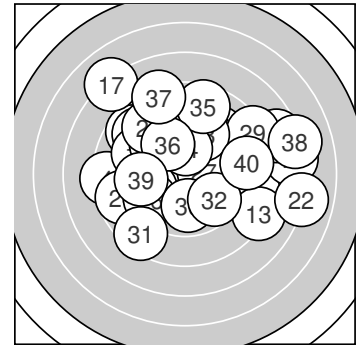

**Serie 1:**  
 8.6 → 9.9 ↗ 9.1 ↖ 8.3 ← 9.2 ↗  
 8.7 ↘ 9.2 → 9.7 ↘ 10.2 \* 9.3 ↗  
 beste Teiler: 179.2 (9.), 266.5 (2.), 310.3 (8.)  
 Trefferlage: 0.00 mm , 2.09 mm hoch  
 Streuwert: 3.02, horizontal: 3.85, vertikal: 1.86

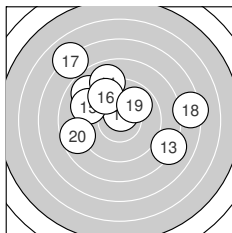

**Serie 2:**  
 10.6 \* 8.9 ↘ 8.1 ↘ 8.9 ↖ 9.2 ↘  
 9.6 ↘ 7.0 ↘ 7.3 → 9.9 ↗ 8.7 ←  
 beste Teiler: 86.4 (11.), 268.7 (19.), 349.5 (16.)  
 Trefferlage: 0.54 mm links, 1.92 mm hoch  
 Streuwert: 4.14, horizontal: 4.96, vertikal: 3.11

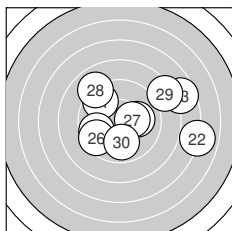

**Serie 3:**  
 9.6 ↘ 6.9 → 7.6 → 10.1 → 9.7 ←  
 9.5 ↖ 10.3 \* 9.0 ↘ 8.3 ↗ 9.9 ↓  
 beste Teiler: 161.1 (27.), 222.2 (24.), 265.1 (30.)  
 Trefferlage: 1.59 mm rechts, 0.55 mm hoch  
 Streuwert: 3.81, horizontal: 4.74, vertikal: 2.56

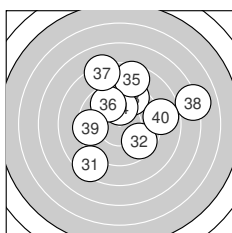

**Serie 4:**  
 8.5 ↖ 9.6 ↘ 9.5 ↗ 10.1 ↑ 8.6 ↗  
 9.8 ↘ 8.2 ↖ 7.1 → 9.5 ← 8.8 →  
 beste Teiler: 212.0 (34.), 290.2 (36.), 326.9 (32.)  
 Trefferlage: 0.89 mm rechts, 1.62 mm hoch  
 Streuwert: 3.79, horizontal: 4.08, vertikal: 3.46



Ergebnis: **354.6** (335)  
 Serien: 90.6 89.7 89.0 85.3  
 Zähler: 6 16 9 5 4 0 0 0 0 0  
 Innenzehner: 1  
 Weitester: 1210 (5.), 1196 (14.), 1089 (37.)  
 beste Teiler: 160.9 (3.), 208.1 (22.), 220.6 (16.)  
 Trefferlage: 1.73 mm links, 0.95 mm hoch  
 Streuwert: 3.99, horizontal: 4.91, vertikal: 2.79

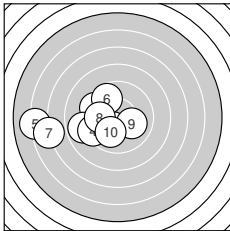
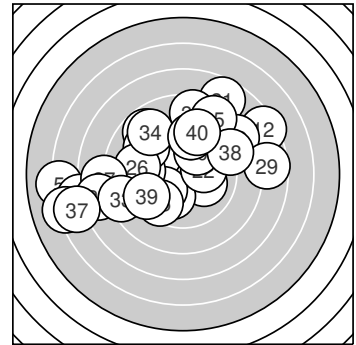

**Serie 1:**

9.5 ↖	8.9 ←	10.3 *	9.3 ←	6.1 ←
9.7 ↘	6.8 ←	9.9 ←	10.1 ↘	10.0 ↙

beste Teiler: 160.9 (3.), 224.4 (9.), 238.3 (10.)  
 Trefferlage: 3.78 mm links, 0.71 mm tief  
 Streuwert: 3.26, horizontal: 4.31, vertikal: 1.62

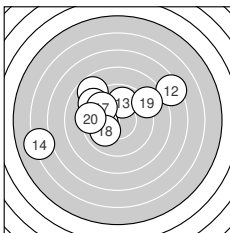

**Serie 2:**

8.8 ↘	7.4 ↗	9.9 ↑	6.2 ←	9.2 ↘
10.1 ←	9.8 ↘	10.0 ↙	8.9 ↗	9.4 ←

beste Teiler: 220.6 (16.), 237.7 (18.), 266.3 (13.)  
 Trefferlage: 1.60 mm links, 1.28 mm hoch  
 Streuwert: 4.06, horizontal: 5.17, vertikal: 2.51

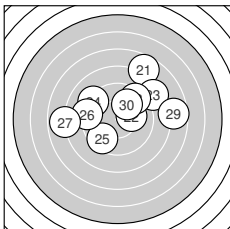

**Serie 3:**

7.7 ↗	10.1 →	8.4 ↗	9.2 ↘	9.5 ↙
9.2 ←	7.9 ←	9.4 ↗	7.7 →	9.9 ↗

beste Teiler: 208.1 (22.), 255.7 (30.), 358.7 (25.)  
 Trefferlage: 0.52 mm rechts, 1.72 mm hoch  
 Streuwert: 3.94, horizontal: 4.88, vertikal: 2.68

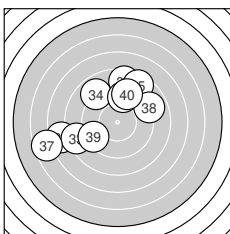

**Serie 4:**

7.5 ←	8.5 ↑	8.4 ←	8.9 ↘	8.5 ↗
9.5 ↑	6.6 ←	8.9 ↗	9.3 ↙	9.2 ↑

beste Teiler: 374.4 (36.), 412.8 (39.), 430.7 (40.)  
 Trefferlage: 2.05 mm links, 1.51 mm hoch  
 Streuwert: 4.38, horizontal: 5.00, vertikal: 3.65



Ergebnis: **398.1** (380)  
 Serien: 98.8 101.7 98.7 98.9  
 Zähler: 21 18 1 0 0 0 0 0 0 0  
 Innenzehner: 15  
 Weitestе: 568 (1.), 451 (21.), 449 (33.)  
 beste Teiler: 53.3 (4.), 90.1 (32.), 100.6 (27.)  
 Trefferlage: 0.38 mm rechts, 0.62 mm hoch  
 Streuwert: 1.89, horizontal: 2.12, vertikal: 1.62

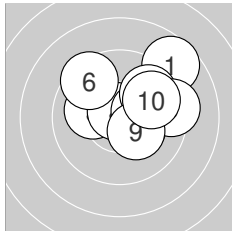
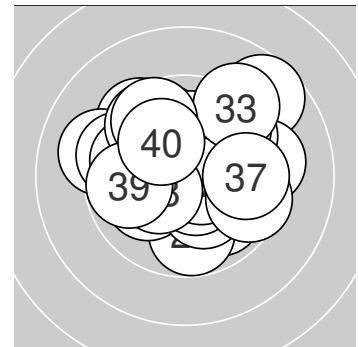

**Serie 1:**

8.7 ↗	10.3 *	10.1 ←	10.7 *	10.3 *
9.5 ↘	9.8 ↗	9.3 →	10.3 *	9.8 ↗

beste Teiler: 53.3 (4.), 158.4 (2.), 165.1 (5.)  
 Trefferlage: 1.22 mm rechts, 1.05 mm hoch  
 Streuwert: 1.91, horizontal: 2.22, vertikal: 1.56

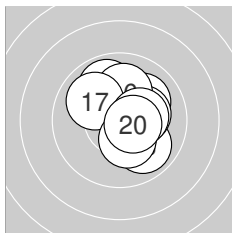

**Serie 2:**

9.9 ↘	10.1 ↗	9.9 ↘	10.4 *	10.2 *
10.1 ↑	10.0 ↘	10.3 *	10.3 *	10.5 *

beste Teiler: 108.5 (20.), 137.1 (14.), 160.0 (19.)  
 Trefferlage: 0.56 mm rechts, 0.60 mm hoch  
 Streuwert: 1.39, horizontal: 1.29, vertikal: 1.48

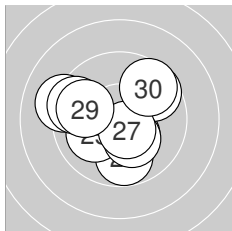

**Serie 3:**

9.1 ←	10.4 *	9.6 ↗	9.8 ↓	10.1 ↗
10.2 *	10.6 *	9.5 ←	9.8 ←	9.6 ↗

beste Teiler: 100.6 (27.), 150.8 (22.), 179.7 (26.)  
 Trefferlage: 0.47 mm links, 0.01 mm hoch  
 Streuwert: 2.12, horizontal: 2.43, vertikal: 1.77

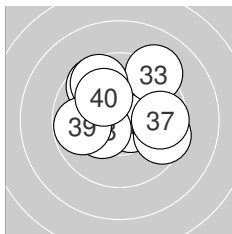

**Serie 4:**

10.4 *	10.6 *	9.2 ↗	9.7 ↘	9.5 →
9.6 ↘	9.7 →	10.3 *	9.8 ←	10.1 ↘

beste Teiler: 90.1 (32.), 130.2 (31.), 153.0 (38.)  
 Trefferlage: 0.23 mm rechts, 0.85 mm hoch  
 Streuwert: 2.03, horizontal: 2.31, vertikal: 1.71



Ergebnis: **387.6** (372)  
 Serien: 94.8 100.8 96.4 95.6  
 Zähler: 20 15 3 1 1 0 0 0 0 0  
 Innenzehner: 13  
 Weitester: 1121 (38.), 911 (9.), 634 (12.)  
 beste Teiler: 42.8 (15.), 81.0 (36.), 124.1 (26.)  
 Trefferlage: 0.08 mm links, 0.44 mm hoch  
 Streuwert: 2.73, horizontal: 3.28, vertikal: 2.02

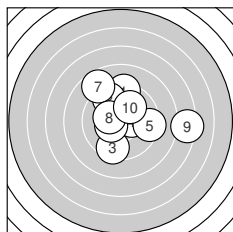
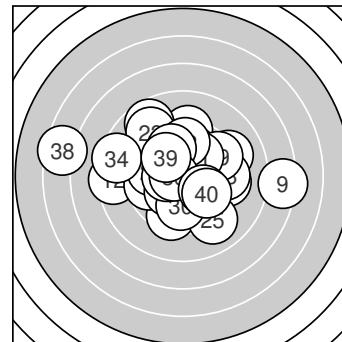

**Serie 1:**  
 9.3 ↑                      9.6 ↘                      9.5 ↓                      10.3 \*                      9.4 →  
 10.4 \*                      8.7 ↘                      10.3 \*                      7.3 →                      10.0 ↗

beste Teiler: 142.6 (6.), 151.1 (4.), 160.9 (8.)  
 Trefferlage: 0.77 mm rechts, 0.90 mm hoch  
 Streuwert: 3.09, horizontal: 3.55, vertikal: 2.56

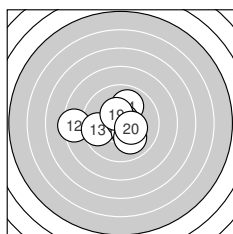

**Serie 2:**  
 10.4 \*                      8.4 ←                      9.7 ←                      10.0 ↗                      10.8 \*  
 10.4 \*                      10.4 \*                      10.0 ↘                      10.4 \*                      10.3 \*

beste Teiler: 42.8 (15.), 133.9 (16.), 137.8 (19.)  
 Trefferlage: 0.29 mm links, 0.22 mm tief  
 Streuwert: 1.99, horizontal: 2.53, vertikal: 1.23

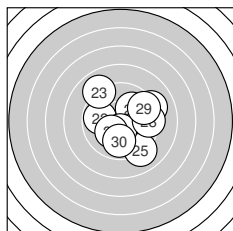

**Serie 3:**  
 9.1 ↗                      9.8 ←                      9.0 ↘                      10.0 ↗                      9.0 ↘  
 10.5 \*                      10.2 \*                      9.4 →                      9.5 ↗                      9.9 ↓

beste Teiler: 124.1 (26.), 191.2 (27.), 230.2 (24.)  
 Trefferlage: 0.81 mm rechts, 0.07 mm hoch  
 Streuwert: 2.53, horizontal: 2.65, vertikal: 2.41

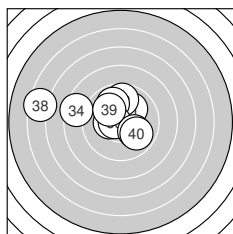

**Serie 4:**  
 10.0 ↗                      9.7 ↑                      10.4 \*                      8.5 ←                      9.9 ↘  
 10.6 \*                      10.1 ↘                      6.5 ←                      10.0 ↘                      9.9 ↘

beste Teiler: 81.0 (36.), 149.0 (33.), 221.8 (37.)  
 Trefferlage: 1.62 mm links, 1.02 mm hoch  
 Streuwert: 3.08, horizontal: 4.04, vertikal: 1.62



Ergebnis: **412.4** (396)  
 Serien: 104.9 103.9 101.5 102.1  
 Zähler: 36 4 0 0 0 0 0 0 0  
 Innenzehner: 28  
 Weitesten: 380 (39.), 283 (22.), 268 (30.)  
 beste Teiler: 4.1 (5.), 12.6 (8.), 13.8 (10.)  
 Trefferlage: 0.36 mm rechts, 0.05 mm tief  
 Streuwert: 1.25, horizontal: 1.26, vertikal: 1.24

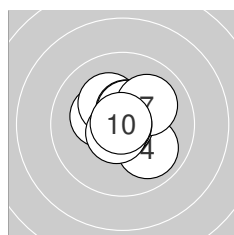
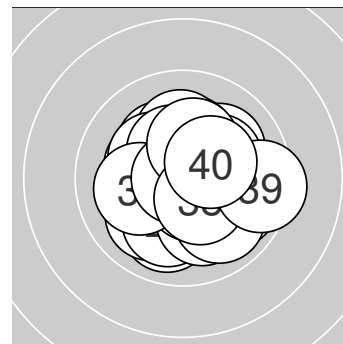

**Serie 1:**  
 10.3 \*                      10.2 \*                      10.5 \*                      10.0 ↘                      10.9 \*  
 10.5 \*                      10.1 ↗                      10.9 \*                      10.6 \*                      10.9 \*  
 beste Teiler: 4.1 (5.), 12.6 (8.), 13.8 (10.)  
 Trefferlage: 0.09 mm rechts, 0.30 mm hoch  
 Streuwert: 1.03, horizontal: 1.07, vertikal: 0.99

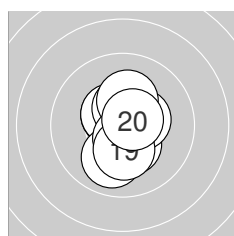

**Serie 2:**  
 10.4 \*                      10.5 \*                      10.4 \*                      10.5 \*                      10.0 ↓  
 10.5 \*                      10.2 \*                      10.6 \*                      10.2 \*                      10.6 \*  
 beste Teiler: 83.7 (20.), 95.1 (18.), 111.0 (12.)  
 Trefferlage: 0.07 mm rechts, 0.10 mm tief  
 Streuwert: 1.11, horizontal: 0.71, vertikal: 1.39

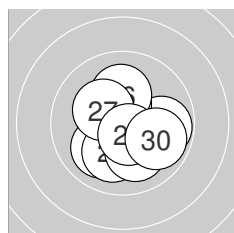

**Serie 3:**  
 10.2 \*                      9.8 →                      10.0 ↙                      10.1 ↓                      10.4 \*  
 10.1 ↑                      10.3 \*                      10.1 ↓                      10.6 \*                      9.9 ↘  
 beste Teiler: 93.9 (29.), 139.7 (25.), 171.1 (27.)  
 Trefferlage: 0.42 mm rechts, 0.46 mm tief  
 Streuwert: 1.49, horizontal: 1.51, vertikal: 1.46

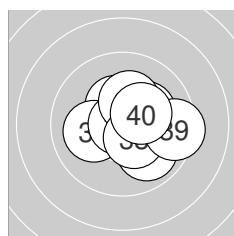

**Serie 4:**  
 10.4 \*                      10.3 \*                      10.1 ←                      10.2 \*                      10.8 \*  
 10.3 \*                      9.9 ↘                      10.4 \*                      9.4 →                      10.3 \*  
 beste Teiler: 27.0 (35.), 129.8 (38.), 140.2 (31.)  
 Trefferlage: 0.86 mm rechts, 0.04 mm hoch  
 Streuwert: 1.37, horizontal: 1.59, vertikal: 1.10





Ergebnis: **398.9** (381)  
 Serien: 99.0 98.5 100.8 100.6  
 Zähler: 22 17 1 0 0 0 0 0 0 0  
 Innenzehner: 17  
 Weitester: 523 (36.), 451 (29.), 431 (13.)  
 beste Teiler: 62.3 (7.), 77.8 (39.), 82.4 (14.)  
 Trefferlage: 0.03 mm links, 0.40 mm tief  
 Streuwert: 1.93, horizontal: 2.05, vertikal: 1.81

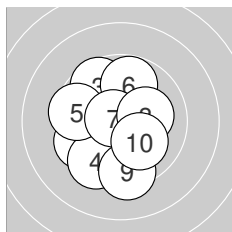
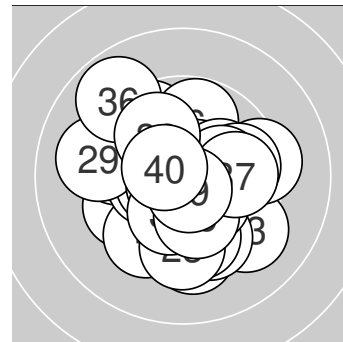

**Serie 1:**

10.5 *	9.6 ↙	9.6 ↘	9.5 ↙	9.6 ↙
9.8 ↑	10.7 *	10.2 *	9.4 ↓	10.1 ↘

beste Teiler: 62.3 (7.), 118.4 (1.), 200.1 (8.)  
 Trefferlage: 0.48 mm links, 0.32 mm tief  
 Streuwert: 2.10, horizontal: 1.93, vertikal: 2.25

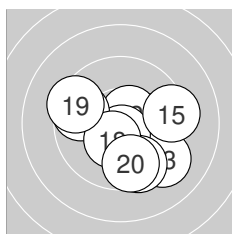

**Serie 2:**

10.0 →	10.6 *	9.2 ↘	10.6 *	9.3 →
9.6 ↘	9.7 ↙	10.4 *	9.4 ↙	9.7 ↓

beste Teiler: 82.4 (14.), 99.0 (12.), 144.4 (18.)  
 Trefferlage: 0.52 mm rechts, 0.73 mm tief  
 Streuwert: 2.17, horizontal: 2.48, vertikal: 1.80

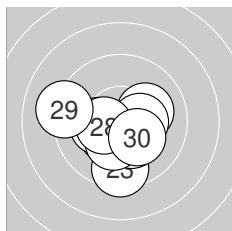

**Serie 3:**

10.1 →	10.3 *	9.5 ↓	10.4 *	10.3 *
10.2 *	10.3 *	10.4 *	9.1 ↙	10.2 *

beste Teiler: 134.3 (28.), 145.6 (24.), 152.1 (22.)  
 Trefferlage: 0.34 mm links, 0.81 mm tief  
 Streuwert: 1.65, horizontal: 1.91, vertikal: 1.34

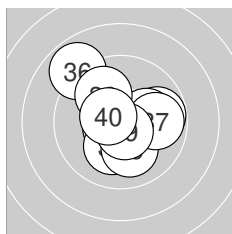

**Serie 4:**

10.6 *	10.2 *	9.8 →	10.1 →	10.1 ↓
8.9 ↘	9.9 →	9.9 ↘	10.6 *	10.5 *

beste Teiler: 77.8 (39.), 86.0 (31.), 106.9 (40.)  
 Trefferlage: 0.15 mm rechts, 0.25 mm hoch  
 Streuwert: 1.89, horizontal: 1.98, vertikal: 1.80



**Ergebnis:** **409.9** (393)  
**Serien:** 102.1 102.4 103.4 102.0  
**Zähler:** 33 7 0 0 0 0 0 0 0 0  
**Innenzehner:** 24  
**Weiteste:** 349 (37.), 335 (33.), 286 (15.)  
**beste Teiler:** 8.2 (4.), 13.0 (35.), 18.4 (17.)  
**Trefferlage:** 0.10 mm links, 0.37 mm hoch  
**Streuwert:** 1.37, horizontal: 1.46, vertikal: 1.26

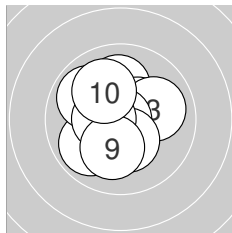
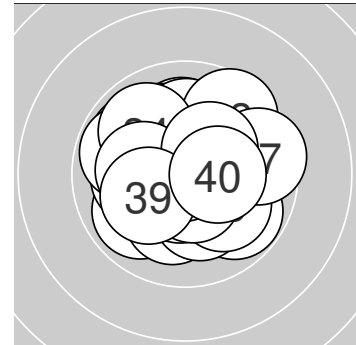

**Serie 1:**  
 10.1 ↑                      10.4 \*                      10.0 →  
 10.3 \*                      9.9 ↘                      10.5 \*  
**beste Teiler:** 8.2 (4.), 117.0 (8.), 137.5 (2.)  
**Trefferlage:** 0.34 mm links, 0.20 mm hoch  
**Streuwert:** 1.46, horizontal: 1.41, vertikal: 1.51

10.9 \*                      9.9 ↙  
 10.1 ↓                      10.0 ↖

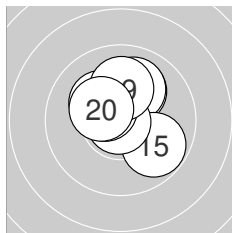

**Serie 2:**  
 10.2 \*                      10.1 ↗                      10.0 ↗  
 10.2 \*                      10.9 \*                      10.4 \*  
**beste Teiler:** 18.4 (17.), 130.4 (14.), 133.2 (18.)  
**Trefferlage:** 0.05 mm links, 1.03 mm hoch  
**Streuwert:** 1.20, horizontal: 1.18, vertikal: 1.23

10.4 \*                      9.8 ↘  
 10.1 ↑                      10.3 \*

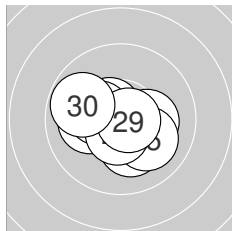

**Serie 3:**  
 10.8 \*                      10.2 \*                      10.1 ←  
 10.6 \*                      10.3 \*                      10.6 \*  
**beste Teiler:** 47.5 (21.), 54.5 (29.), 97.5 (28.)  
**Trefferlage:** 0.23 mm links, 0.28 mm tief  
**Streuwert:** 1.25, horizontal: 1.54, vertikal: 0.88

10.2 \*                      10.1 ↘  
 10.7 \*                      9.8 ↖

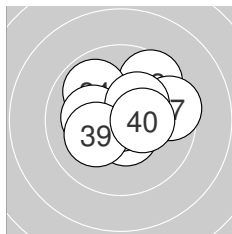

**Serie 4:**  
 10.5 \*                      10.5 \*                      9.6 ↗  
 10.2 \*                      9.6 →                      10.3 \*  
**beste Teiler:** 13.0 (35.), 101.3 (31.), 107.8 (32.)  
**Trefferlage:** 0.21 mm rechts, 0.54 mm hoch  
**Streuwert:** 1.52, horizontal: 1.81, vertikal: 1.16

9.9 ↘                      10.9 \*  
 10.2 \*                      10.3 \*



Ergebnis: **394.1** (376)  
 Serien: 98.4 99.2 98.4 98.1  
 Zähler: 21 15 3 1 0 0 0 0 0 0  
 Innenzehner: 12  
 Weitester: 800 (9.), 572 (2.), 521 (12.)  
 beste Teiler: 2.2 (36.), 50.4 (4.), 78.0 (32.)  
 Trefferlage: 0.11 mm rechts, 0.50 mm tief  
 Streuwert: 2.25, horizontal: 2.81, vertikal: 1.47

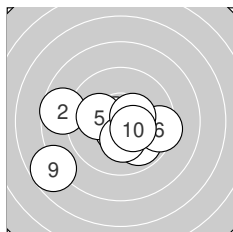
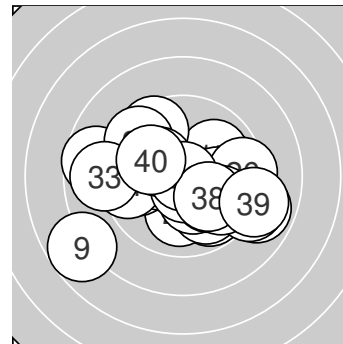

**Serie 1:**  
 9.9 ↘                      8.7 ←                      10.6 \*                      10.8 \*                      10.1 ←  
 9.4 →                      10.3 \*                      10.4 \*                      7.8 ↙                      10.4 \*  
 beste Teiler: 50.4 (4.), 90.2 (3.), 127.0 (8.)  
 Trefferlage: 0.68 mm links, 0.86 mm tief  
 Streuwert: 2.57, horizontal: 3.25, vertikal: 1.64

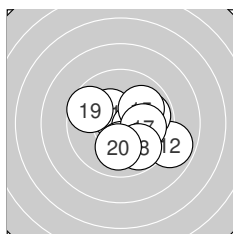

**Serie 2:**  
 10.4 \*                      8.9 ↘                      9.9 →                      10.4 \*                      10.0 ↗  
 10.1 ↓                      10.1 →                      9.8 ↘                      9.6 ↖                      10.0 ↓  
 beste Teiler: 140.6 (14.), 149.3 (11.), 208.1 (16.)  
 Trefferlage: 1.06 mm rechts, 0.48 mm tief  
 Streuwert: 1.90, horizontal: 2.17, vertikal: 1.59

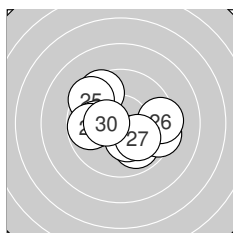

**Serie 3:**  
 9.9 ↘                      9.4 →                      10.3 \*                      9.6 ↖                      9.5 ↖  
 9.4 →                      10.1 ↘                      10.0 ←                      9.8 ←                      10.4 \*  
 beste Teiler: 137.0 (30.), 164.7 (23.), 217.1 (27.)  
 Trefferlage: 0.00 mm , 0.10 mm tief  
 Streuwert: 2.19, horizontal: 2.62, vertikal: 1.63

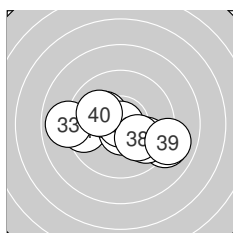

**Serie 4:**  
 9.5 ←                      10.6 \*                      8.9 ←                      10.2 \*                      9.1 →  
 10.9 \*                      9.8 ↘                      10.1 ↘                      9.0 →                      10.0 ↖  
 beste Teiler: 2.2 (36.), 78.0 (32.), 185.2 (34.)  
 Trefferlage: 0.08 mm rechts, 0.58 mm tief  
 Streuwert: 2.41, horizontal: 3.24, vertikal: 1.08



Ergebnis: **400.9** (383)  
 Serien: 101.6 99.3 100.6 99.4  
 Zähler: 25 13 2 0 0 0 0 0 0 0  
 Innenzehner: 19  
 Weitest: 666 (35.), 622 (1.), 480 (11.)  
 beste Teiler: 10.8 (6.), 35.1 (8.), 55.1 (7.)  
 Trefferlage: 0.04 mm rechts, 0.07 mm tief  
 Streuwert: 1.96, horizontal: 2.15, vertikal: 1.75

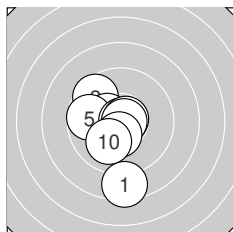
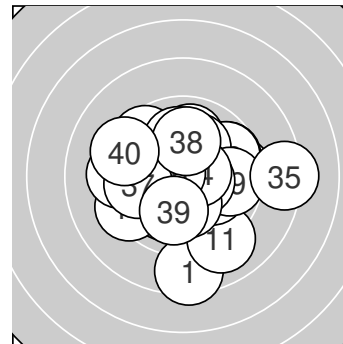

**Serie 1:**  
 8.5 ↓                      9.6 ↘                      10.6 \*                      10.4 \*                      9.7 ←  
 10.9 \*                      10.7 \*                      10.8 \*                      10.4 \*                      10.0 ↙  
 beste Teiler: 10.8 (6.), 35.1 (8.), 55.1 (7.)  
 Trefferlage: 0.70 mm links, 0.67 mm tief  
 Streuwert: 1.83, horizontal: 1.26, vertikal: 2.27

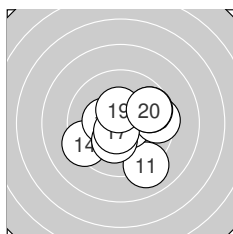

**Serie 2:**  
 9.0 ↘                      10.6 \*                      9.5 →                      9.3 ←                      10.3 \*  
 10.2 \*                      10.6 \*                      9.7 ↗                      10.4 \*                      9.7 →  
 beste Teiler: 79.3 (12.), 86.3 (17.), 132.5 (19.)  
 Trefferlage: 0.62 mm rechts, 0.43 mm tief  
 Streuwert: 2.05, horizontal: 2.30, vertikal: 1.76

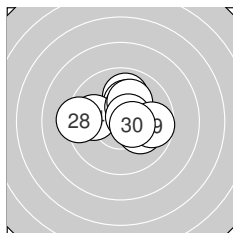

**Serie 3:**  
 10.1 ↘                      9.9 ↑                      10.2 \*                      9.9 ←                      10.3 \*  
 10.1 ↗                      10.6 \*                      9.3 ←                      9.7 →                      10.5 \*  
 beste Teiler: 87.3 (27.), 119.3 (30.), 156.0 (25.)  
 Trefferlage: 0.28 mm rechts, 0.68 mm hoch  
 Streuwert: 1.69, horizontal: 2.10, vertikal: 1.14

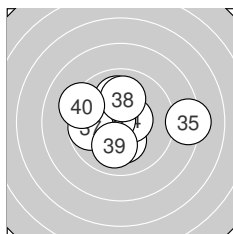

**Serie 4:**  
 10.6 \*                      10.2 \*                      10.0 ↑                      10.6 \*                      8.3 →  
 10.6 \*                      9.8 ←                      10.0 ↑                      10.0 ↓                      9.3 ↘  
 beste Teiler: 80.5 (36.), 90.5 (31.), 96.7 (34.)  
 Trefferlage: 0.03 mm links, 0.12 mm hoch  
 Streuwert: 2.27, horizontal: 2.78, vertikal: 1.58



Ergebnis: **384.7** (369)  
 Serien: 99.3 96.9 92.1 96.4  
 Zähler: 17 18 2 3 0 0 0 0 0 0  
 Innenzehner: 10  
 Weitester: 960 (23.), 913 (21.), 854 (22.)  
 beste Teiler: 26.9 (10.), 29.7 (25.), 41.0 (34.)  
 Trefferlage: 0.97 mm links, 0.72 mm hoch  
 Streuwert: 2.71, horizontal: 3.28, vertikal: 1.99

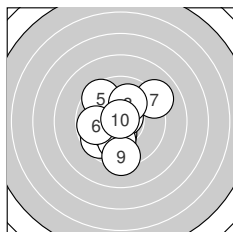
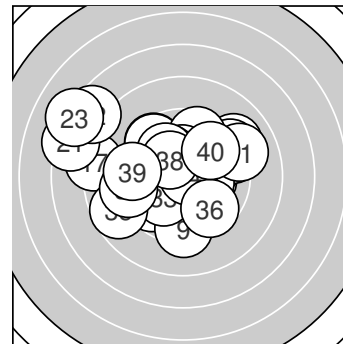

**Serie 1:**  
 10.3 \*                      10.7 \*                      9.7 ↙  
    9.8 ←                      9.1 ↗                      10.0 ↑  
 beste Teiler: 26.9 (10.), 63.2 (2.), 153.2 (1.)  
 Trefferlage: 0.32 mm links, 0.22 mm tief  
 Streuwert: 2.13, horizontal: 1.97, vertikal: 2.27

10.0 ↓                      9.6 ↘  
 9.3 ↓                      10.8 \*

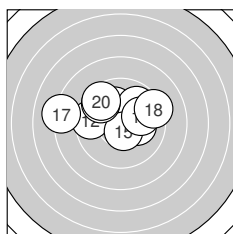

**Serie 2:**  
 10.1 ↖                      9.5 ←                      10.2 \*                      9.8 ↗  
    10.0 →                      8.1 ←                      9.3 ↗                      9.7 ↘                      10.6 \*  
 beste Teiler: 99.9 (15.), 195.9 (13.), 209.3 (11.)  
 Trefferlage: 0.53 mm links, 1.16 mm hoch  
 Streuwert: 2.46, horizontal: 3.27, vertikal: 1.17

9.6 ↘                      10.8 \*  
 10.2 \*

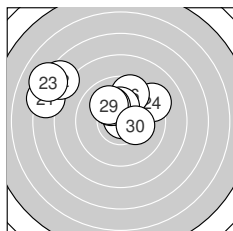

**Serie 3:**  
 7.3 ↖                      7.5 ↖                      7.1 ↖                      9.2 ↗                      10.8 \*  
    9.6 ↑                      10.3 \*                      10.1 ↖                      10.0 ↘                      10.2 \*  
 beste Teiler: 29.7 (25.), 174.0 (27.), 179.5 (30.)  
 Trefferlage: 2.00 mm links, 2.24 mm hoch  
 Streuwert: 3.36, horizontal: 4.45, vertikal: 1.67

10.8 \*                      8.7 ↙  
 9.8 ↗                      9.6 ↘

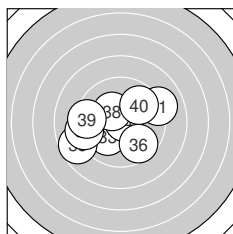

**Serie 4:**  
 9.0 →                      9.5 ←                      10.1 ↙                      10.8 \*                      8.7 ↙  
    9.6 ↘                      9.2 ←                      10.3 \*                      9.4 ←                      9.8 ↗  
 beste Teiler: 41.0 (34.), 160.7 (38.), 221.5 (33.)  
 Trefferlage: 1.03 mm links, 0.28 mm tief  
 Streuwert: 2.57, horizontal: 3.22, vertikal: 1.68

10.8 \*                      8.7 ↙  
 9.4 ←                      9.8 ↗



Ergebnis: **399.1** (381)  
 Serien: 100.9 99.1 97.2 101.9  
 Zähler: 22 17 1 0 0 0 0 0 0  
 Innenzehner: 12  
 Weitester: 572 (24.), 499 (17.), 395 (22.)  
 beste Teiler: 40.1 (14.), 47.8 (31.), 48.3 (38.)  
 Trefferlage: 0.29 mm rechts, 0.52 mm hoch  
 Streuwert: 1.91, horizontal: 2.01, vertikal: 1.80

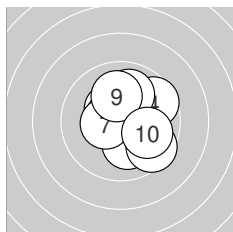
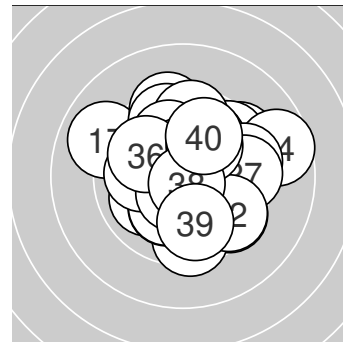

**Serie 1:**  
 10.1 ↓                      10.4 \*                      10.3 \*                      9.6 →                      10.0 ↑  
 10.6 \*                      10.4 \*                      9.5 ↘                      10.1 ↑                      9.9 →  
 beste Teiler: 92.1 (6.), 132.5 (7.), 143.8 (2.)  
 Trefferlage: 0.57 mm rechts, 0.38 mm hoch  
 Streuwert: 1.63, horizontal: 1.57, vertikal: 1.69

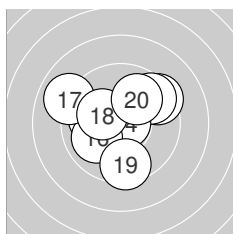

**Serie 2:**  
 10.7 \*                      9.4 →                      9.6 →                      10.8 \*                      10.0 ←  
 10.0 ←                      9.0 ←                      10.2 \*                      9.5 ↓                      9.9 ↑  
 beste Teiler: 40.1 (14.), 66.8 (11.), 178.8 (18.)  
 Trefferlage: 0.30 mm links, 0.45 mm hoch  
 Streuwert: 2.16, horizontal: 2.42, vertikal: 1.87

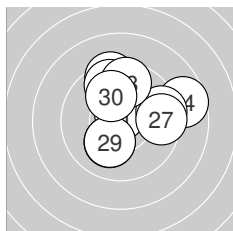

**Serie 3:**  
 10.7 \*                      9.4 ↑                      9.6 ↑                      8.7 →                      9.5 →  
 10.1 ↓                      9.5 →                      9.6 ↑                      10.1 ↓                      10.0 ↑  
 beste Teiler: 56.0 (21.), 204.4 (29.), 208.0 (26.)  
 Trefferlage: 0.84 mm rechts, 1.22 mm hoch  
 Streuwert: 2.23, horizontal: 2.43, vertikal: 2.02

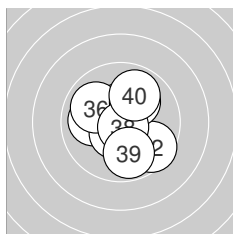

**Serie 4:**  
 10.8 \*                      9.6 ↘                      10.0 ←                      10.5 \*                      10.5 \*  
 9.9 ↘                      10.1 →                      10.8 \*                      9.8 ↓                      9.9 ↑  
 beste Teiler: 47.8 (31.), 48.3 (38.), 110.9 (34.)  
 Trefferlage: 0.07 mm rechts, 0.01 mm hoch  
 Streuwert: 1.61, horizontal: 1.55, vertikal: 1.67



Ergebnis: **381.5** (364)  
 Serien: 89.9 98.5 97.4 95.7  
 Zähler: 15 18 3 4 0 0 0 0 0 0  
 Innenzehner: 9  
 Weitestе: 941 (5.), 893 (6.), 867 (4.)  
 beste Teiler: 64.3 (37.), 70.4 (14.), 77.4 (23.)  
 Trefferlage: 0.13 mm rechts, 0.52 mm hoch  
 Streuwert: 2.94, horizontal: 3.63, vertikal: 2.03

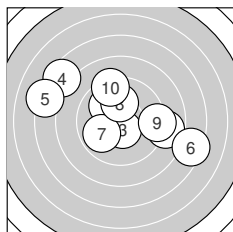
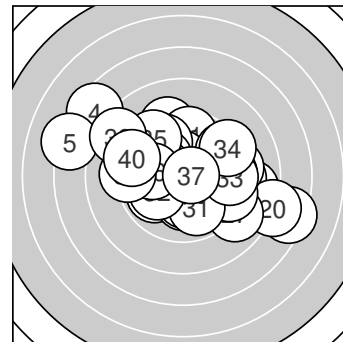

**Serie 1:**  
 8.8 → 10.0 ↘ 10.5 \* 7.5 ↘ 7.2 ←  
 7.4 → 9.9 ↗ 10.1 ↑ 9.2 → 9.3 ↑  
 beste Teiler: 102.1 (3.), 218.3 (8.), 239.9 (2.)  
 Trefferlage: 0.27 mm links, 0.92 mm hoch  
 Streuwert: 4.22, horizontal: 5.34, vertikal: 2.65

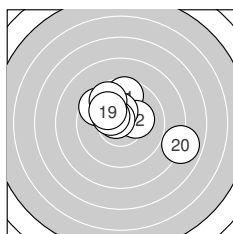

**Serie 2:**  
 9.6 ↑ 10.2 \* 10.4 \* 10.7 \* 9.9 ↘  
 9.6 ↘ 10.4 \* 9.7 ↘ 10.1 ↘ 7.9 →  
 beste Teiler: 70.4 (14.), 140.6 (17.), 143.2 (13.)  
 Trefferlage: 0.01 mm rechts, 1.21 mm hoch  
 Streuwert: 2.28, horizontal: 2.80, vertikal: 1.61

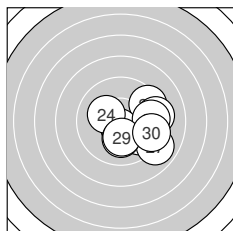

**Serie 3:**  
 9.8 ↘ 9.4 ↗ 10.6 \* 10.2 \* 9.3 →  
 9.5 → 8.9 ↘ 10.1 ↓ 10.2 \* 9.4 →  
 beste Teiler: 77.4 (23.), 189.2 (24.), 190.5 (29.)  
 Trefferlage: 1.93 mm rechts, 0.70 mm tief  
 Streuwert: 1.89, horizontal: 2.16, vertikal: 1.58

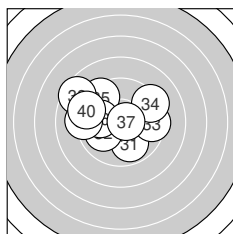

**Serie 4:**  
 9.9 ↘ 10.0 ↗ 9.5 → 9.3 ↗ 9.4 ↘  
 10.0 ← 10.7 \* 8.5 ↘ 9.2 ← 9.2 ←  
 beste Teiler: 64.3 (37.), 238.5 (32.), 245.1 (36.)  
 Trefferlage: 1.14 mm links, 0.67 mm hoch  
 Streuwert: 2.61, horizontal: 3.21, vertikal: 1.81



Ergebnis: **170.0** (159)  
 Serien: 87.1 82.9  
 Zähler: 4 4 4 5 2 0 1 0 0 0  
 Innenzehner: 3  
 Weitestе: 1516 (16.), 1093 (14.), 1013 (4.)  
 beste Teiler: 145.0 (11.), 181.2 (3.), 187.4 (17.)  
 Trefferlage: 0.14 mm rechts, 1.45 mm hoch  
 Streuwert: 5.08, horizontal: 6.65, vertikal: 2.70

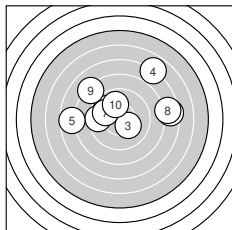
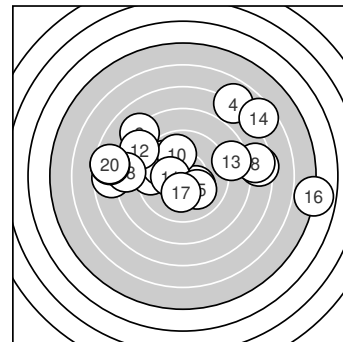

**Serie 1:**

9.5 ←	7.4 →	10.2 *	6.9 ↗	7.7 ←
9.8 ↘	9.9 ↖	7.6 →	8.2 ↘	9.9 ↑

beste Teiler: 181.2 (3.), 262.7 (10.), 268.4 (7.)  
 Trefferlage: 0.20 mm rechts, 2.02 mm hoch  
 Streuwert: 4.50, horizontal: 5.74, vertikal: 2.76

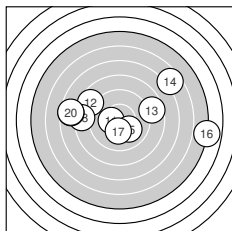

**Serie 2:**

10.4 *	8.6 ↘	8.6 →	6.6 ↗	10.1 ↘
4.9 →	10.2 *	8.3 ←	7.6 ←	7.6 ←

beste Teiler: 145.0 (11.), 187.4 (17.), 220.6 (15.)  
 Trefferlage: 0.08 mm rechts, 0.88 mm hoch  
 Streuwert: 5.81, horizontal: 7.77, vertikal: 2.66





**Ergebnis: 191.8 (184)**  
**Serien: 95.0 96.8**  
**Zähler: 7 11 1 1 0 0 0 0 0 0**  
**Innenzehner: 3**  
**Weiteste: 811 (4.), 618 (12.), 484 (8.)**  
**beste Teiler: 114.1 (11.), 169.3 (15.), 170.4 (17.)**  
**Trefferlage: 0.77 mm links, 1.23 mm hoch**  
**Streuwert: 2.55, horizontal: 2.76, vertikal: 2.33**

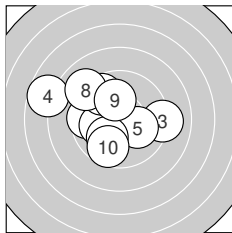
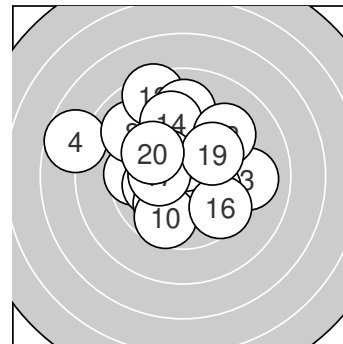

**Serie 1:**

9.6 ←	10.1 ←	9.1 →	7.7 ←	10.1 →
10.0 ↙	9.6 ↘	9.0 ↘	10.1 ↑	9.7 ↓

**beste Teiler: 211.2 (5.), 212.4 (9.), 221.4 (2.)**  
**Trefferlage: 1.53 mm links, 0.40 mm hoch**  
**Streuwert: 2.77, horizontal: 3.30, vertikal: 2.11**

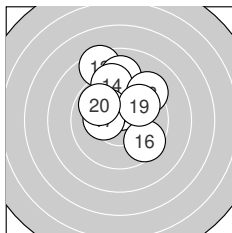

**Serie 2:**

10.5 *	8.5 ↖	9.1 ↑	9.4 ↑	10.3 *
9.6 ↘	10.3 *	9.3 ↗	9.9 ↗	9.9 ↘

**beste Teiler: 114.1 (11.), 169.3 (15.), 170.4 (17.)**  
**Trefferlage: 0.01 mm links, 2.07 mm hoch**  
**Streuwert: 2.17, horizontal: 1.97, vertikal: 2.34**



Ergebnis: **367.9** (352)  
 Serien: 90.4 93.4 92.8 91.3  
 Zähler: 9 17 11 3 0 0 0 0 0 0  
 Innenzehner: 3  
 Weitester: 917 (22.), 856 (3.), 767 (1.)  
 beste Teiler: 43.2 (21.), 132.8 (27.), 157.9 (10.)  
 Trefferlage: 0.01 mm links, 1.48 mm hoch  
 Streuwert: 3.30, horizontal: 3.87, vertikal: 2.60

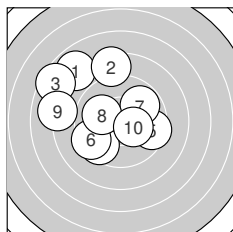
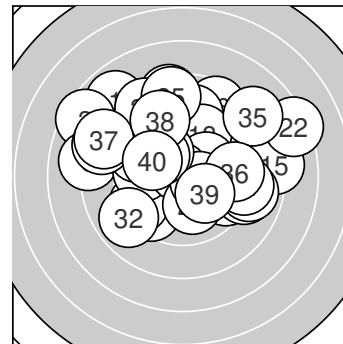

**Serie 1:**

7.9 ↘	8.4 ↑	7.5 ↖	9.5 ↙	9.5 →
9.4 ↙	9.8 ↗	10.1 ↖	8.0 ←	10.3 *

beste Teiler: 157.9 (10.), 225.4 (8.), 282.2 (7.)  
 Trefferlage: 2.14 mm links, 1.35 mm hoch  
 Streuwert: 3.48, horizontal: 3.78, vertikal: 3.15

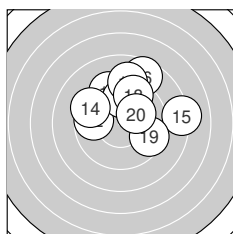

**Serie 2:**

9.4 ↖	9.7 ←	9.8 ↑	9.4 ↘	8.2 →
8.6 ↗	9.1 ↑	9.6 ↗	9.5 ↘	10.1 ↗

beste Teiler: 207.0 (20.), 284.5 (13.), 306.7 (12.)  
 Trefferlage: 0.90 mm rechts, 2.21 mm hoch  
 Streuwert: 2.64, horizontal: 3.09, vertikal: 2.10

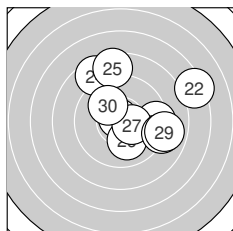

**Serie 3:**

10.8 *	7.3 ↗	9.3 →	8.6 ↖	8.5 ↑
10.0 ↓	10.4 *	9.0 →	8.9 →	10.0 ↖

beste Teiler: 43.2 (21.), 132.8 (27.), 226.7 (26.)  
 Trefferlage: 1.84 mm rechts, 1.19 mm hoch  
 Streuwert: 3.22, horizontal: 3.53, vertikal: 2.87

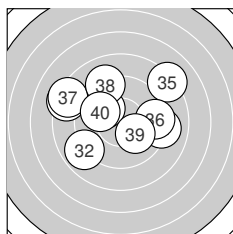

**Serie 4:**

10.0 ↘	8.9 ↙	8.3 ↖	9.1 →	8.2 ↗
9.4 →	8.3 ↖	9.1 ↖	10.1 ↘	9.9 ↖

beste Teiler: 210.8 (39.), 233.0 (31.), 260.2 (40.)  
 Trefferlage: 0.65 mm links, 1.18 mm hoch  
 Streuwert: 3.49, horizontal: 4.29, vertikal: 2.45



Ergebnis: **398.4** (377)  
 Serien: 100.3 97.8 98.0 102.3  
 Zähler: 21 15 4 0 0 0 0 0 0 0  
 Innenzehner: 17  
 Weitester: 622 (27.), 620 (18.), 547 (22.)  
 beste Teiler: 34.9 (38.), 67.6 (1.), 85.0 (29.)  
 Trefferlage: 0.16 mm links, 0.87 mm hoch  
 Streuwert: 1.96, horizontal: 2.15, vertikal: 1.75

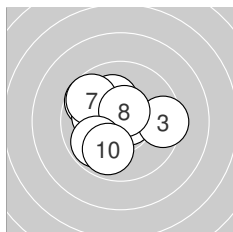
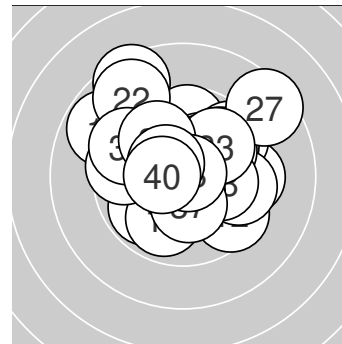

**Serie 1:**  
 10.7 \*                      10.1 ↙                      9.5 →                      9.7 ↘                      10.1 ←  
 10.2 \*                      9.7 ↘                      10.6 \*                      9.8 ↙                      9.9 ↘  
 beste Teiler: 67.6 (1.), 93.6 (8.), 196.2 (6.)  
 Trefferlage: 0.78 mm links, 0.08 mm hoch  
 Streuwert: 1.78, horizontal: 1.95, vertikal: 1.59

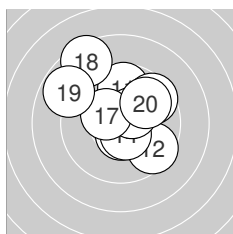

**Serie 2:**  
 9.7 ↑                      9.5 ↘                      10.6 \*                      10.5 \*                      9.6 ↗  
 10.4 \*                      10.4 \*                      8.5 ↘                      8.8 ↘                      9.8 ↗  
 beste Teiler: 99.0 (13.), 106.5 (14.), 133.7 (16.)  
 Trefferlage: 0.06 mm rechts, 1.27 mm hoch  
 Streuwert: 2.34, horizontal: 2.42, vertikal: 2.27

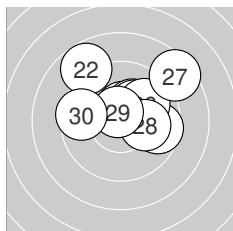

**Serie 3:**  
 10.5 \*                      8.8 ↘                      10.2 \*                      9.6 →                      10.2 \*  
 9.9 ↗                      8.5 ↗                      10.1 →                      10.6 \*                      9.6 ←  
 beste Teiler: 85.0 (29.), 124.0 (21.), 177.2 (23.)  
 Trefferlage: 0.79 mm rechts, 1.45 mm hoch  
 Streuwert: 2.16, horizontal: 2.57, vertikal: 1.67

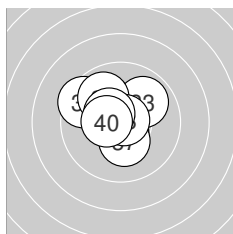

**Serie 4:**  
 10.2 \*                      10.1 ↘                      9.9 ↗                      9.5 ↘                      9.9 ↘  
 10.6 \*                      10.3 \*                      10.8 \*                      10.5 \*                      10.5 \*  
 beste Teiler: 34.9 (38.), 90.4 (36.), 122.2 (40.)  
 Trefferlage: 0.70 mm links, 0.70 mm hoch  
 Streuwert: 1.35, horizontal: 1.44, vertikal: 1.26



Ergebnis: **382.0** (362)  
 Serien: 97.9 95.1 92.0 97.0  
 Zähler: 16 13 8 3 0 0 0 0 0 0  
 Innenzehner: 11  
 Weitester: 895 (29.), 790 (14.), 770 (24.)  
 beste Teiler: 6.3 (10.), 41.9 (7.), 76.0 (13.)  
 Trefferlage: 0.80 mm links, 0.03 mm tief  
 Streuwert: 2.90, horizontal: 3.46, vertikal: 2.19

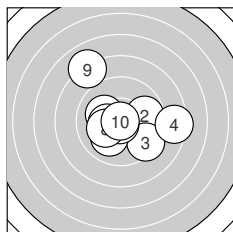
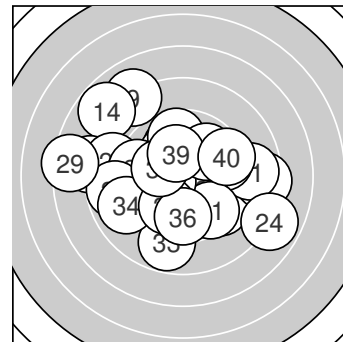

**Serie 1:**  
 10.1 ↖ 9.8 → 9.4 ↘ 8.4 → 10.0 ↗  
 10.3 \* 10.8 \* 10.2 \* 8.0 ↘ 10.9 \*  
 beste Teiler: 6.3 (10.), 41.9 (7.), 160.3 (6.)  
 Trefferlage: 0.14 mm rechts, 0.16 mm hoch  
 Streuwert: 2.72, horizontal: 3.04, vertikal: 2.35

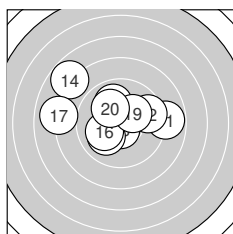

**Serie 2:**  
 8.8 → 9.6 → 10.6 \* 7.8 ↘ 10.0 ↗  
 10.1 ↖ 8.0 ← 9.9 ↗ 10.2 \* 10.1 ↘  
 beste Teiler: 76.0 (13.), 183.6 (19.), 214.1 (20.)  
 Trefferlage: 0.90 mm links, 0.95 mm hoch  
 Streuwert: 3.02, horizontal: 3.82, vertikal: 1.92

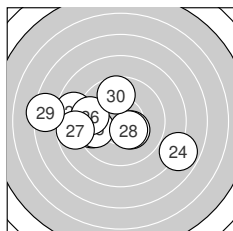

**Serie 3:**  
 8.7 ← 9.6 ← 10.3 \* 7.9 ↘ 9.7 ←  
 9.5 ← 8.8 ← 10.4 \* 7.4 ← 9.7 ↑  
 beste Teiler: 139.4 (28.), 158.9 (23.), 313.3 (25.)  
 Trefferlage: 2.13 mm links, 0.25 mm tief  
 Streuwert: 3.38, horizontal: 4.42, vertikal: 1.81

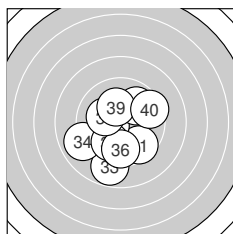

**Serie 4:**  
 9.6 ↘ 10.4 \* 8.8 ↓ 8.9 ↖ 9.9 ↗  
 9.7 ↓ 9.9 ↗ 10.2 \* 10.2 \* 9.4 →  
 beste Teiler: 129.9 (32.), 187.2 (39.), 192.9 (38.)  
 Trefferlage: 0.31 mm links, 1.02 mm tief  
 Streuwert: 2.37, horizontal: 2.29, vertikal: 2.46



Ergebnis: **412.0** (395)  
 Serien: 101.8 102.2 104.0 104.0  
 Zähler: 35 5 0 0 0 0 0 0 0 0  
 Innenzehner: 29  
 Weitester: 390 (5.), 302 (6.), 271 (18.)  
 beste Teiler: 61.6 (33.), 63.1 (25.), 79.7 (34.)  
 Trefferlage: 0.39 mm rechts, 0.18 mm hoch  
 Streuwert: 1.24, horizontal: 1.41, vertikal: 1.04

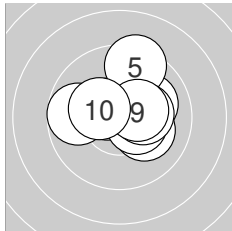
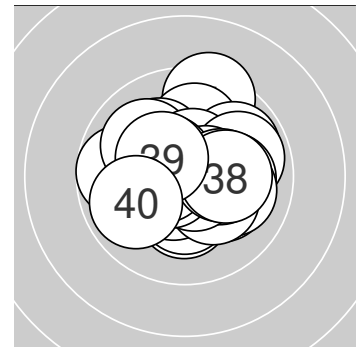

**Serie 1:**

10.1 ↗	10.5 *	10.1 ↘	10.6 *	9.4 ↑
9.7 ←	10.4 *	10.3 *	10.4 *	10.3 *

beste Teiler: 99.0 (4.), 104.2 (2.), 130.9 (7.)  
 Trefferlage: 0.47 mm rechts, 0.58 mm hoch  
 Streuwert: 1.47, horizontal: 1.68, vertikal: 1.23

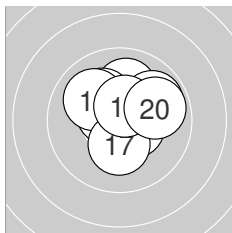

**Serie 2:**

10.0 ↑	10.4 *	10.5 *	10.2 *	10.5 *
10.0 ↘	10.3 *	9.9 ↗	10.5 *	9.9 ↗

beste Teiler: 101.5 (13.), 108.5 (19.), 113.1 (15.)  
 Trefferlage: 0.41 mm rechts, 0.71 mm hoch  
 Streuwert: 1.32, horizontal: 1.47, vertikal: 1.15

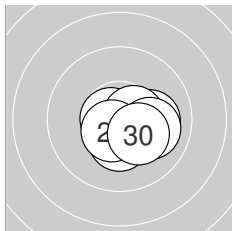

**Serie 3:**

10.6 *	10.1 →	10.4 *	10.6 *	10.7 *
10.3 *	10.5 *	10.0 ↘	10.5 *	10.3 *

beste Teiler: 63.1 (25.), 82.7 (21.), 89.4 (24.)  
 Trefferlage: 0.81 mm rechts, 0.57 mm tief  
 Streuwert: 0.79, horizontal: 0.99, vertikal: 0.53

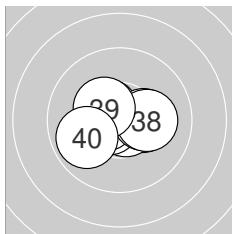

**Serie 4:**

10.3 *	10.5 *	10.7 *	10.6 *	10.6 *
10.5 *	10.3 *	10.2 *	10.4 *	9.9 ↗

beste Teiler: 61.6 (33.), 79.7 (34.), 99.3 (35.)  
 Trefferlage: 0.11 mm links, 0.00 mm  
 Streuwert: 1.13, horizontal: 1.48, vertikal: 0.61



Ergebnis: **411.9** (396)  
 Serien: 102.2 102.0 104.2 103.5  
 Zähler: 36 4 0 0 0 0 0 0 0  
 Innenzehner: 31  
 Weitestе: 429 (1.), 415 (19.), 298 (18.)  
 beste Teiler: 55.7 (15.), 64.4 (28.), 66.6 (27.)  
 Trefferlage: 0.08 mm rechts, 0.01 mm tief  
 Streuwert: 1.33, horizontal: 1.31, vertikal: 1.34

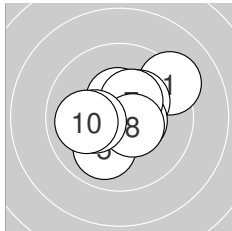
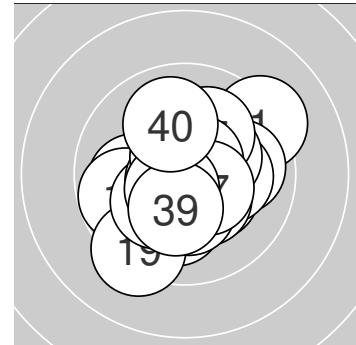

**Serie 1:**

9.2 ↗	10.3 *	10.7 *	10.4 *	10.0 ↘
10.5 *	10.4 *	10.5 *	10.2 *	10.0 ←

beste Teiler: 75.6 (3.), 109.6 (8.), 116.4 (6.)  
 Trefferlage: 0.29 mm rechts, 0.29 mm hoch  
 Streuwert: 1.52, horizontal: 1.72, vertikal: 1.28

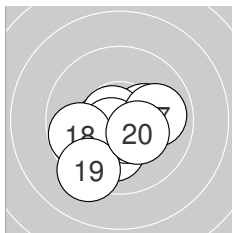

**Serie 2:**

10.1 ↓	10.2 *	10.6 *	10.5 *	10.7 *
10.6 *	9.9 →	9.8 ←	9.3 ↘	10.3 *

beste Teiler: 55.7 (15.), 87.1 (16.), 93.1 (13.)  
 Trefferlage: 0.16 mm links, 0.85 mm tief  
 Streuwert: 1.47, horizontal: 1.69, vertikal: 1.20

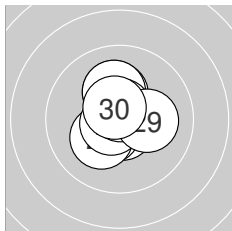

**Serie 3:**

10.2 *	10.2 *	10.7 *	10.5 *	10.2 *
10.2 *	10.7 *	10.7 *	10.2 *	10.6 *

beste Teiler: 64.4 (28.), 66.6 (27.), 70.2 (23.)  
 Trefferlage: 0.18 mm links, 0.38 mm hoch  
 Streuwert: 1.05, horizontal: 0.86, vertikal: 1.22

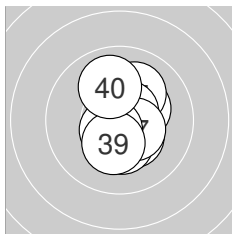

**Serie 4:**

10.4 *	10.4 *	10.3 *	10.3 *	10.1 ↗
10.6 *	10.5 *	10.6 *	10.3 *	10.0 ↑

beste Teiler: 77.8 (36.), 93.5 (38.), 120.9 (37.)  
 Trefferlage: 0.40 mm rechts, 0.12 mm hoch  
 Streuwert: 1.16, horizontal: 0.76, vertikal: 1.46



Ergebnis: **395.5** (380)  
 Serien: 98.7 98.7 100.2 97.9  
 Zähler: 22 16 2 0 0 0 0 0 0 0  
 Innenzehner: 14  
 Weitestе: 631 (32.), 525 (7.), 463 (36.)  
 beste Teiler: 41.6 (3.), 99.0 (12.), 117.1 (27.)  
 Trefferlage: 0.07 mm rechts, 0.17 mm hoch  
 Streuwert: 2.11, horizontal: 2.35, vertikal: 1.84

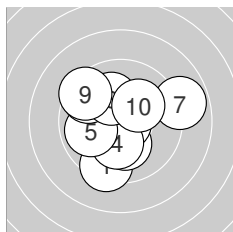
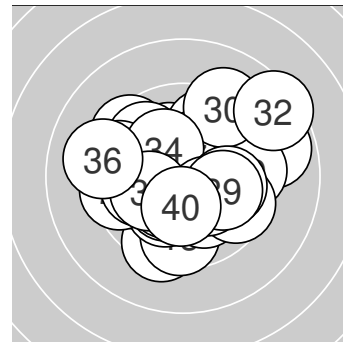

**Serie 1:**  
 9.4 ↙ 10.2 \* 10.8 \* 10.2 \* 9.9 ←  
 9.6 ↘ 8.9 → 10.1 ↗ 9.4 ↘ 10.2 \*  
 beste Teiler: 41.6 (3.), 183.4 (4.), 194.9 (2.)  
 Trefferlage: 0.32 mm links, 0.07 mm hoch  
 Streuwert: 2.24, horizontal: 2.39, vertikal: 2.08

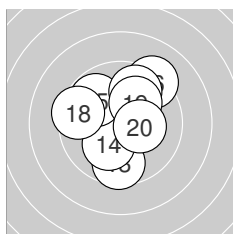

**Serie 2:**  
 9.7 ↖ 10.6 \* 9.6 ↓ 10.1 ↘ 9.8 ↘  
 9.2 ↗ 9.8 ↗ 9.5 ↖ 10.1 ↗ 10.3 \*  
 beste Teiler: 99.0 (12.), 165.2 (20.), 202.0 (14.)  
 Trefferlage: 0.23 mm links, 0.71 mm hoch  
 Streuwert: 2.08, horizontal: 2.11, vertikal: 2.05

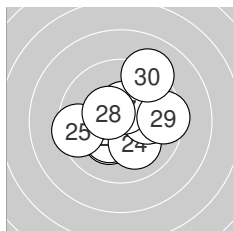

**Serie 3:**  
 10.3 \* 10.3 \* 10.3 \* 10.1 ↘ 9.5 ←  
 10.0 → 10.5 \* 10.5 \* 9.5 → 9.2 ↗  
 beste Teiler: 117.1 (27.), 124.2 (28.), 153.0 (21.)  
 Trefferlage: 0.43 mm rechts, 0.01 mm hoch  
 Streuwert: 1.91, horizontal: 2.12, vertikal: 1.68

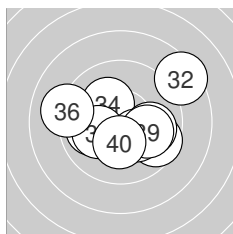

**Serie 4:**  
 10.0 ← 8.4 ↗ 9.6 ↘ 10.2 \* 10.1 ←  
 9.1 ↖ 9.9 → 10.3 \* 10.0 → 10.3 \*  
 beste Teiler: 171.3 (40.), 175.2 (38.), 188.9 (34.)  
 Trefferlage: 0.41 mm rechts, 0.09 mm tief  
 Streuwert: 2.39, horizontal: 2.94, vertikal: 1.68



Ergebnis: **361.1** (340)  
 Serien: 91.6 92.9 86.8 89.8  
 Zähler: 7 14 13 4 2 0 0 0 0 0  
 Innenzehner: 4  
 Weitester: 1114 (33.), 1068 (28.), 926 (37.)  
 beste Teiler: 136.6 (7.), 138.9 (19.), 160.7 (1.)  
 Trefferlage: 1.47 mm links, 1.02 mm hoch  
 Streuwert: 3.67, horizontal: 3.80, vertikal: 3.54

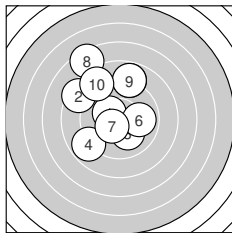
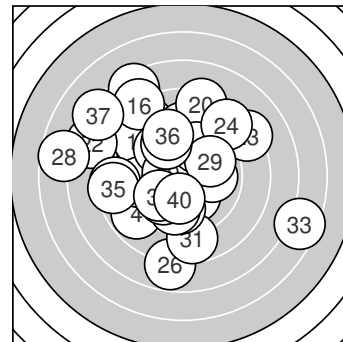

**Serie 1:**

10.3 *	8.4 ↖	10.1 ↘	8.8 ↙	8.8 ↑
9.9 →	10.4 *	7.4 ↗	8.8 ↑	8.7 ↘

beste Teiler: 136.6 (7.), 160.7 (1.), 211.1 (3.)  
 Trefferlage: 1.30 mm links, 2.05 mm hoch  
 Streuwert: 3.24, horizontal: 2.82, vertikal: 3.61

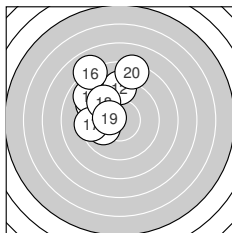

**Serie 2:**

9.7 ↖	9.2 ↑	9.3 ↖	10.0 ↙	8.9 ↘
8.0 ↘	9.4 ←	9.7 ↘	10.4 *	8.3 ↑

beste Teiler: 138.9 (19.), 237.5 (14.), 319.3 (11.)  
 Trefferlage: 2.20 mm links, 2.49 mm hoch  
 Streuwert: 2.26, horizontal: 1.85, vertikal: 2.61

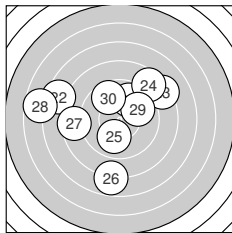

**Serie 3:**

9.8 ↗	7.5 ↖	8.3 ↗	8.6 ↗	10.0 ↓
7.8 ↓	8.5 ←	6.7 ←	9.9 ↗	9.7 ↘

beste Teiler: 241.3 (25.), 274.3 (29.), 280.9 (21.)  
 Trefferlage: 1.48 mm links, 0.89 mm hoch  
 Streuwert: 4.53, horizontal: 5.26, vertikal: 3.65

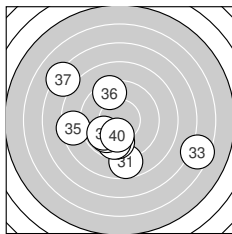

**Serie 4:**

8.7 ↓	9.8 ↓	6.5 ↘	9.7 ↓	8.5 ←
9.4 ↘	7.2 ↖	9.9 ↙	9.9 ↙	10.2 *

beste Teiler: 200.5 (40.), 268.2 (38.), 271.4 (39.)  
 Trefferlage: 0.90 mm links, 1.32 mm tief  
 Streuwert: 4.12, horizontal: 4.75, vertikal: 3.37





Ergebnis: **361.3** (342)  
 Serien: 91.3 88.5 95.6 85.9  
 Zähler: 10 11 13 4 1 1 0 0 0 0  
 Innenzehner: 7  
 Weitester: 1254 (20.), 1149 (15.), 957 (33.)  
 beste Teiler: 78.5 (22.), 127.4 (23.), 139.8 (19.)  
 Trefferlage: 1.66 mm links, 2.25 mm tief  
 Streuwert: 3.44, horizontal: 3.73, vertikal: 3.12

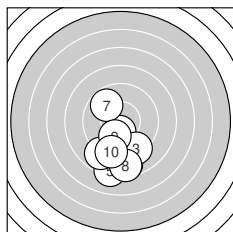
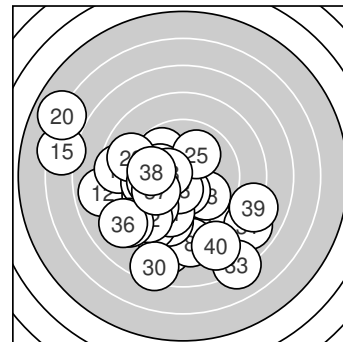

**Serie 1:**  
 10.4 \*                      8.5 ↓                      9.2 ↘                      8.5 ↓                      8.2 ↓  
    8.9 ↗                      9.8 ↖                      8.5 ↓                      10.1 ↓                      9.2 ↓  
 beste Teiler: 143.5 (1.), 219.6 (9.), 295.5 (7.)  
 Trefferlage: 0.52 mm links, 3.87 mm tief  
 Streuwert: 2.23, horizontal: 1.46, vertikal: 2.79

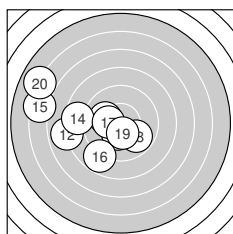

**Serie 2:**  
 10.3 \*                      7.9 ←                      10.1 ↖                      8.6 ←                      6.4 ←  
    8.8 ↗                      10.3 \*                      9.8 ↘                      10.4 \*                      5.9 ↖  
 beste Teiler: 139.8 (19.), 154.9 (11.), 169.7 (17.)  
 Trefferlage: 4.05 mm links, 0.11 mm tief  
 Streuwert: 3.86, horizontal: 4.71, vertikal: 2.76

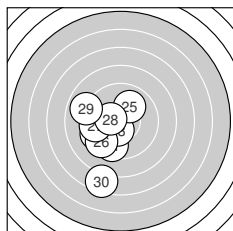

**Serie 3:**  
 9.5 ↓                      10.6 \*                      10.4 \*                      9.4 ←                      10.0 ↗  
    9.4 ↗                      9.5 ←                      10.4 \*                      8.9 ↖                      7.5 ↓  
 beste Teiler: 78.5 (22.), 127.4 (23.), 141.6 (28.)  
 Trefferlage: 1.94 mm links, 1.42 mm tief  
 Streuwert: 2.46, horizontal: 1.78, vertikal: 2.99

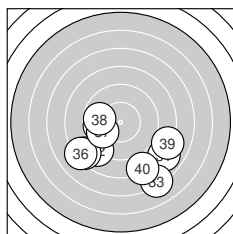

**Serie 4:**  
 7.9 ↘                      8.9 ↗                      7.1 ↓                      9.8 ←                      8.3 ↗  
    8.1 ↗                      9.8 ←                      9.8 ←                      8.1 ↘                      8.1 ↓  
 beste Teiler: 282.7 (37.), 295.7 (38.), 299.8 (34.)  
 Trefferlage: 0.15 mm links, 3.59 mm tief  
 Streuwert: 3.84, horizontal: 4.74, vertikal: 2.65



Ergebnis: **360.1** (342)  
 Serien: 88.1 89.3 93.0 89.7  
 Zähler: 5 19 12 2 1 1 0 0 0 0  
 Innenzehner: 4  
 Weitester: 1488 (34.), 1005 (16.), 901 (1.)  
 beste Teiler: 35.9 (38.), 79.3 (12.), 126.6 (24.)  
 Trefferlage: 0.20 mm links, 0.10 mm tief  
 Streuwert: 3.94, horizontal: 4.43, vertikal: 3.38

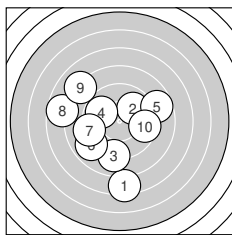
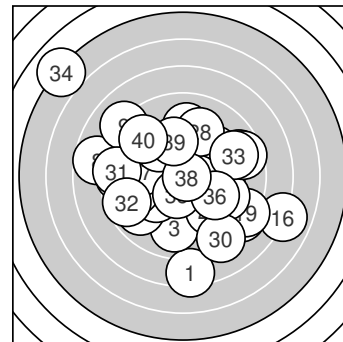

**Serie 1:**  
 7.3 ↓                      9.9 ↗                      9.0 ↓                      9.8 ↖                      8.7 →  
 8.9 ↙                      9.2 ←                      7.7 ←                      8.1 ↘                      9.5 →  
 beste Teiler: 258.1 (2.), 282.6 (4.), 358.6 (10.)  
 Trefferlage: 1.37 mm links, 0.76 mm tief  
 Streuwert: 4.10, horizontal: 4.20, vertikal: 4.00

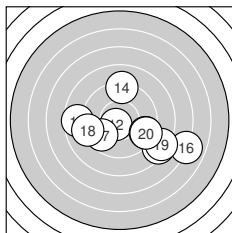

**Serie 2:**  
 8.3 ↘                      10.6 \*                      8.6 ←                      9.1 ↑                      9.4 →  
 6.9 ↘                      9.7 ↙                      9.1 ←                      8.3 ↘                      9.3 →  
 beste Teiler: 79.3 (12.), 322.5 (17.), 398.5 (15.)  
 Trefferlage: 1.47 mm rechts, 1.41 mm tief  
 Streuwert: 3.87, horizontal: 4.89, vertikal: 2.46

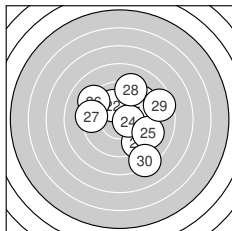

**Serie 3:**  
 9.4 ↗                      10.1 ↘                      9.3 ↘                      10.4 \*                      9.2 →  
 9.2 ↘                      9.4 ←                      9.2 ↑                      8.6 →                      8.2 ↘  
 beste Teiler: 126.6 (24.), 211.0 (22.), 382.1 (21.)  
 Trefferlage: 1.28 mm rechts, 0.21 mm hoch  
 Streuwert: 3.11, horizontal: 3.18, vertikal: 3.04

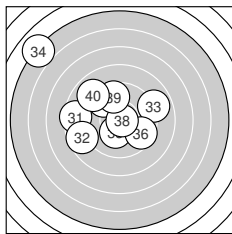

**Serie 4:**  
 8.5 ←                      8.6 ←                      8.9 →                      5.0 ↘                      10.2 \*  
 9.6 ↘                      9.6 ↘                      10.8 \*                      9.6 ↑                      8.9 ↘  
 beste Teiler: 35.9 (38.), 177.0 (35.), 333.9 (39.)  
 Trefferlage: 2.19 mm links, 1.54 mm hoch  
 Streuwert: 4.16, horizontal: 4.67, vertikal: 3.57



**Ergebnis:** **402.9** (383)  
**Serien:** 100.5 100.1 101.0 101.3  
**Zähler:** 25 13 2 0 0 0 0 0 0 0  
**Innenzehner:** 23  
**Weiteste:** 543 (22.), 536 (1.), 450 (19.)  
**beste Teiler:** 11.0 (15.), 13.0 (14.), 32.2 (39.)  
**Trefferlage:** 0.27 mm links, 0.56 mm tief  
**Streuwert:** 1.85, horizontal: 2.07, vertikal: 1.59

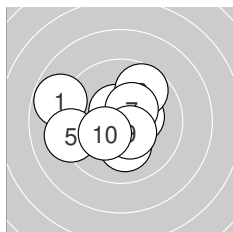
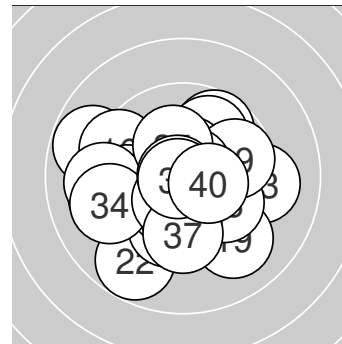

**Serie 1:**  
 8.8 ↖                      10.6 \*                      10.5 \*                      10.4 \*                      9.2 ←  
 9.7 ↗                      10.4 \*                      10.1 ↓                      10.5 \*                      10.3 \*  
**beste Teiler:** 96.6 (2.), 115.3 (3.), 122.7 (9.)  
**Trefferlage:** 0.61 mm links, 0.03 mm hoch  
**Streuwert:** 1.96, horizontal: 2.32, vertikal: 1.50

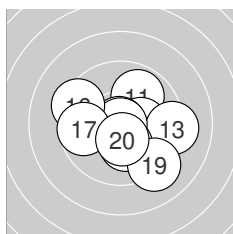

**Serie 2:**  
 9.9 ↗                      10.3 \*                      9.2 →                      10.9 \*                      10.9 \*  
 9.4 ↖                      9.7 ←                      10.2 \*                      9.2 ↘                      10.4 \*  
**beste Teiler:** 11.0 (15.), 13.0 (14.), 136.7 (20.)  
**Trefferlage:** 0.40 mm rechts, 0.39 mm tief  
**Streuwert:** 2.07, horizontal: 2.43, vertikal: 1.62

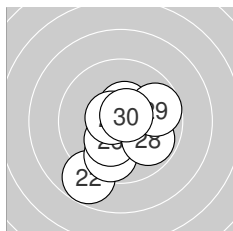

**Serie 3:**  
 10.4 \*                      8.8 ↙                      10.4 \*                      9.8 ↓                      10.5 \*  
 10.2 \*                      10.6 \*                      9.9 ↘                      9.7 →                      10.7 \*  
**beste Teiler:** 69.3 (30.), 81.3 (27.), 115.8 (25.)  
**Trefferlage:** 0.03 mm rechts, 1.04 mm tief  
**Streuwert:** 1.73, horizontal: 1.62, vertikal: 1.84

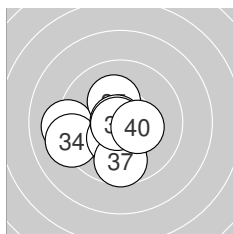

**Serie 4:**  
 9.2 ←                      10.6 \*                      10.0 ↓                      9.2 ←                      10.2 \*  
 10.4 \*                      9.7 ↓                      10.8 \*                      10.8 \*                      10.4 \*  
**beste Teiler:** 32.2 (39.), 33.3 (38.), 83.1 (32.)  
**Trefferlage:** 0.92 mm links, 0.84 mm tief  
**Streuwert:** 1.64, horizontal: 1.86, vertikal: 1.39



Ergebnis: **356.2** (339)  
 Serien: 89.8 84.9 88.0 93.5  
 Zähler: 8 11 15 4 2 0 0 0 0 0  
 Innenzehner: 6  
 Weitester: 1218 (22.), 1141 (12.), 974 (18.)  
 beste Teiler: 96.5 (38.), 99.6 (4.), 157.0 (29.)  
 Trefferlage: 0.59 mm links, 2.44 mm tief  
 Streuwert: 3.74, horizontal: 3.91, vertikal: 3.56

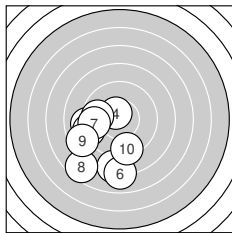
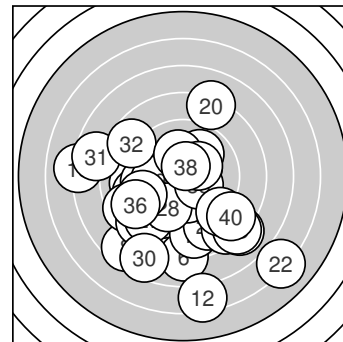

**Serie 1:**  
 9.1 ←                      8.3 ↓                      9.1 ←                      10.6 \*                      9.7 ←  
 8.0 ↓                      9.5 ←                      7.6 ↗                      8.6 ↗                      9.3 ↓  
 beste Teiler: 99.6 (4.), 310.9 (5.), 357.6 (7.)  
 Trefferlage: 2.63 mm links, 2.90 mm tief  
 Streuwert: 2.75, horizontal: 2.34, vertikal: 3.11

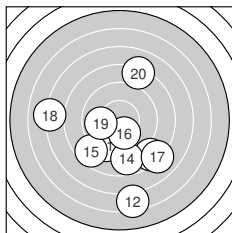

**Serie 2:**  
 9.4 ↗                      6.4 ↓                      8.4 ↘                      8.8 ↓                      8.6 ↗  
 10.2 \*                      8.0 ↘                      7.1 ←                      9.9 ←                      8.1 ↗  
 beste Teiler: 189.4 (16.), 264.2 (19.), 396.8 (11.)  
 Trefferlage: 0.25 mm links, 2.91 mm tief  
 Streuwert: 4.56, horizontal: 4.44, vertikal: 4.68

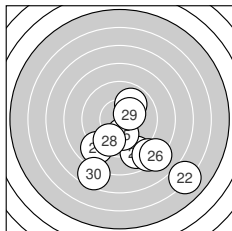

**Serie 3:**  
 8.9 ↘                      6.1 ↘                      9.9 ↗                      8.4 ↘                      10.1 ↓  
 8.1 ↘                      8.9 ↗                      9.7 ↗                      10.3 \*                      7.6 ↗  
 beste Teiler: 157.0 (29.), 212.1 (25.), 257.8 (23.)  
 Trefferlage: 1.55 mm rechts, 3.63 mm tief  
 Streuwert: 3.57, horizontal: 3.86, vertikal: 3.25

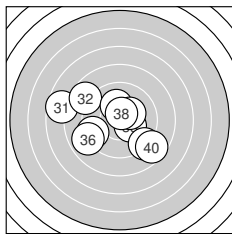

**Serie 4:**  
 7.7 ←                      8.7 ↘                      10.3 \*                      10.1 ↑                      9.3 ←  
 8.9 ↗                      10.3 \*                      10.6 \*                      9.0 ↘                      8.6 ↘  
 beste Teiler: 96.5 (38.), 168.2 (33.), 170.0 (37.)  
 Trefferlage: 1.03 mm links, 0.33 mm tief  
 Streuwert: 3.32, horizontal: 4.03, vertikal: 2.42



Ergebnis: **332.5** (314)  
 Serien: 85.4 86.2 78.9 82.0  
 Zähler: 2 13 12 7 3 2 1 0 0 0  
 Innenzehner: 2  
 Weitestе: 1618 (3.), 1442 (31.), 1353 (29.)  
 beste Teiler: 79.2 (5.), 141.4 (7.), 267.3 (10.)  
 Trefferlage: 1.23 mm rechts, 1.05 mm tief  
 Streuwert: 5.23, horizontal: 5.04, vertikal: 5.41

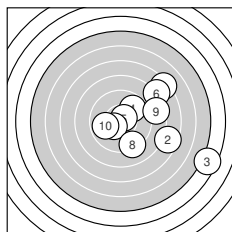
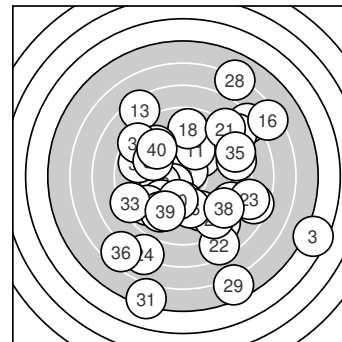

**Serie 1:**  
 7.2 ↗ 7.5 ↘ 4.5 ↘ 9.8 ↗ 10.6 \*  
 7.9 ↗ 10.4 \* 9.2 ↘ 8.4 → 9.9 ←  
 beste Teiler: 79.2 (5.), 141.4 (7.), 267.3 (10.)  
 Trefferlage: 4.29 mm rechts, 0.02 mm tief  
 Streuwert: 4.57, horizontal: 5.14, vertikal: 3.93

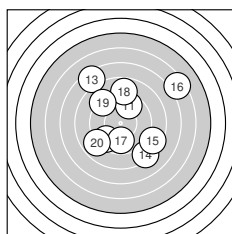

**Serie 2:**  
 9.6 ↗ 9.5 ↙ 7.4 ↘ 8.2 ↘ 8.5 ↘  
 6.4 ↗ 9.8 ↓ 8.8 ↑ 9.1 ↘ 8.9 ↙  
 beste Teiler: 289.0 (17.), 328.4 (11.), 363.7 (12.)  
 Trefferlage: 0.68 mm rechts, 0.84 mm hoch  
 Streuwert: 4.67, horizontal: 4.62, vertikal: 4.72

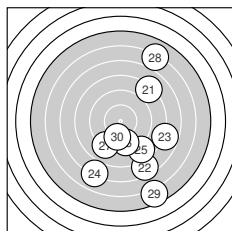

**Serie 3:**  
 8.1 ↗ 7.5 ↘ 7.8 ↘ 7.0 ↙ 8.6 ↘  
 9.5 ↘ 9.0 ↙ 6.0 ↗ 5.5 ↘ 9.9 ↓  
 beste Teiler: 270.8 (30.), 368.6 (26.), 477.9 (27.)  
 Trefferlage: 2.47 mm rechts, 3.03 mm tief  
 Streuwert: 5.53, horizontal: 3.96, vertikal: 6.74

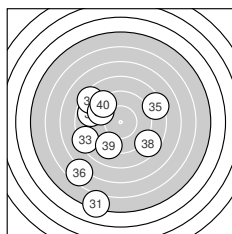

**Serie 4:**  
 5.2 ↓ 8.8 ↖ 8.3 ↙ 8.4 ↖ 8.3 →  
 6.5 ↙ 9.4 ↖ 8.6 ↘ 9.2 ↓ 9.3 ↖  
 beste Teiler: 380.6 (37.), 425.0 (40.), 441.8 (39.)  
 Trefferlage: 2.49 mm links, 2.00 mm tief  
 Streuwert: 5.10, horizontal: 4.36, vertikal: 5.74



Ergebnis: **395.1** (379)  
 Serien: 99.8 100.0 97.9 97.4  
 Zähler: 20 19 1 0 0 0 0 0 0 0  
 Innenzehner: 12  
 Weitester: 748 (37.), 495 (38.), 466 (39.)  
 beste Teiler: 42.0 (1.), 59.8 (34.), 83.0 (20.)  
 Trefferlage: 0.61 mm links, 0.43 mm hoch  
 Streuwert: 2.12, horizontal: 2.21, vertikal: 2.02

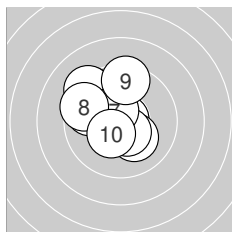
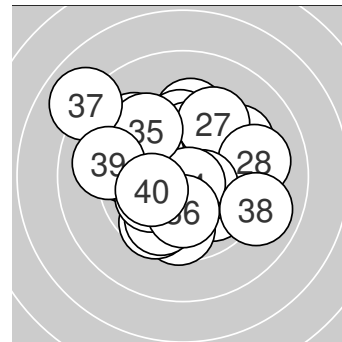

**Serie 1:**  
 10.8 \*                      10.2 \*                      10.5 \*                      9.4 ↘                      9.3 ↘  
 9.8 ↖                      10.5 \*                      9.5 ↖                      9.4 ↑                      10.4 \*  
 beste Teiler: 42.0 (1.), 113.3 (7.), 115.7 (3.)  
 Trefferlage: 1.06 mm links, 0.92 mm hoch  
 Streuwert: 1.79, horizontal: 1.76, vertikal: 1.83

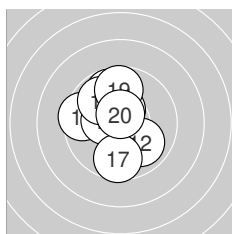

**Serie 2:**  
 10.1 ↘                      9.9 ↘                      9.5 ↖                      10.4 \*                      10.5 \*  
 9.8 ↖                      9.6 ↓                      9.9 ↘                      9.7 ↑                      10.6 \*  
 beste Teiler: 83.0 (20.), 125.0 (15.), 145.3 (14.)  
 Trefferlage: 0.49 mm links, 0.41 mm hoch  
 Streuwert: 1.84, horizontal: 1.55, vertikal: 2.09

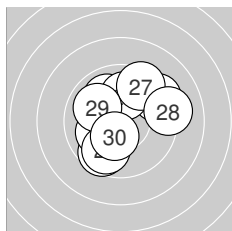

**Serie 3:**  
 9.6 ↗                      9.3 ↗                      10.1 ↖                      10.0 ↘                      10.0 ↑  
 9.8 ↗                      9.5 ↗                      9.2 →                      10.0 ↖                      10.4 \*  
 beste Teiler: 149.4 (30.), 218.7 (23.), 236.6 (25.)  
 Trefferlage: 0.10 mm rechts, 0.41 mm hoch  
 Streuwert: 2.28, horizontal: 2.34, vertikal: 2.21

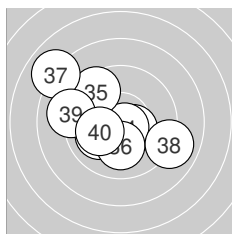

**Serie 4:**  
 10.5 \*                      10.0 ↖                      10.4 \*                      10.7 \*                      9.5 ↘  
 10.1 ↓                      8.0 ↘                      9.0 ↘                      9.1 ↖                      10.1 ↖  
 beste Teiler: 59.8 (34.), 112.2 (31.), 132.4 (33.)  
 Trefferlage: 1.00 mm links, 0.01 mm tief  
 Streuwert: 2.62, horizontal: 3.02, vertikal: 2.14



Ergebnis: **371.9** (354)  
 Serien: 92.0 89.9 96.2 93.8  
 Zähler: 11 15 11 3 0 0 0 0 0 0  
 Innenzehner: 4  
 Weitester: 892 (14.), 774 (21.), 752 (13.)  
 beste Teiler: 105.3 (25.), 145.4 (22.), 153.3 (35.)  
 Trefferlage: 0.74 mm links, 0.64 mm hoch  
 Streuwert: 3.19, horizontal: 3.72, vertikal: 2.55

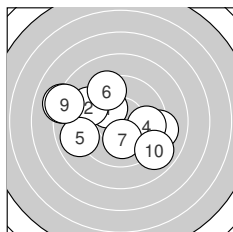
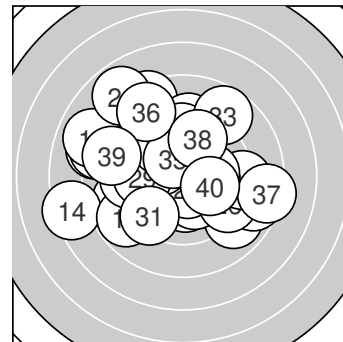

**Serie 1:**  
 10.1 ↘                      9.3 ↘                      9.2 →                      9.7 →                      8.9 ←  
 9.4 ↘                      10.1 ↓                      8.1 ←                      8.3 ←                      8.9 ↘  
 beste Teiler: 204.8 (7.), 205.7 (1.), 302.1 (4.)  
 Trefferlage: 1.31 mm links, 0.21 mm hoch  
 Streuwert: 3.31, horizontal: 4.12, vertikal: 2.23

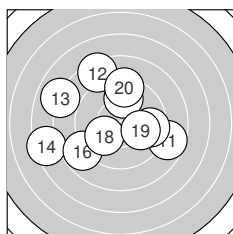

**Serie 2:**  
 8.7 →                      8.4 ↘                      7.9 ↘                      7.4 ←                      9.6 →  
 8.8 ↙                      9.8 ↑                      10.0 ↙                      10.0 →                      9.3 ↑  
 beste Teiler: 235.2 (18.), 243.5 (19.), 285.9 (17.)  
 Trefferlage: 1.25 mm links, 0.52 mm hoch  
 Streuwert: 3.87, horizontal: 4.48, vertikal: 3.13

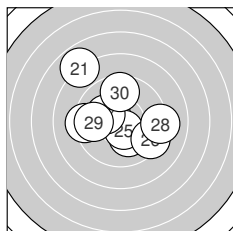

**Serie 3:**  
 7.9 ↘                      10.4 \*                      10.1 ↓                      9.3 ←                      10.5 \*  
 9.4 ↘                      10.2 \*                      9.1 →                      9.7 ←                      9.6 ↑  
 beste Teiler: 105.3 (25.), 145.4 (22.), 190.2 (27.)  
 Trefferlage: 0.56 mm links, 0.56 mm hoch  
 Streuwert: 2.78, horizontal: 3.04, vertikal: 2.49

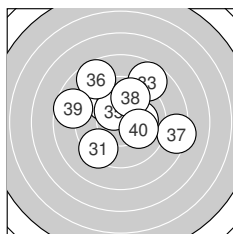

**Serie 4:**  
 9.4 ↙                      9.8 ↘                      8.7 ↗                      10.1 →                      10.3 \*  
 8.7 ↘                      8.3 →                      9.7 ↑                      8.7 ←                      10.1 →  
 beste Teiler: 153.3 (35.), 209.3 (34.), 220.5 (40.)  
 Trefferlage: 0.14 mm rechts, 1.27 mm hoch  
 Streuwert: 3.05, horizontal: 3.47, vertikal: 2.56



Ergebnis: **406.3** (387)  
 Serien: 101.3 99.6 100.7 104.7  
 Zähler: 29 9 2 0 0 0 0 0 0  
 Innenzehner: 24  
 Weitester: 551 (19.), 526 (1.), 494 (23.)  
 beste Teiler: 26.4 (18.), 32.8 (7.), 35.0 (14.)  
 Trefferlage: 0.84 mm rechts, 0.88 mm hoch  
 Streuwert: 1.49, horizontal: 1.74, vertikal: 1.19

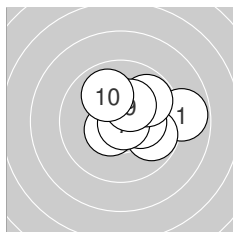
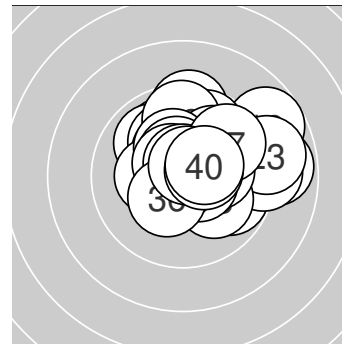

**Serie 1:**  
 8.8 →                      10.7 \*                      9.8 ↘                      10.3 \*                      10.5 \*  
 10.3 \*                      10.8 \*                      9.8 ↗                      10.3 \*                      10.0 ↖  
 beste Teiler: 32.8 (7.), 58.0 (2.), 114.3 (5.)  
 Trefferlage: 1.07 mm rechts, 0.59 mm hoch  
 Streuwert: 1.59, horizontal: 1.94, vertikal: 1.13

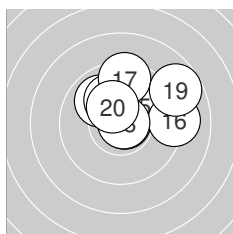

**Serie 2:**  
 10.4 \*                      9.9 ↘                      10.1 ↖                      10.8 \*                      10.1 ↗  
 9.1 →                      9.4 ↑                      10.8 \*                      8.7 ↗                      10.3 \*  
 beste Teiler: 26.4 (18.), 35.0 (14.), 135.0 (11.)  
 Trefferlage: 0.94 mm rechts, 1.47 mm hoch  
 Streuwert: 1.77, horizontal: 2.17, vertikal: 1.23

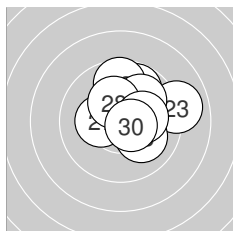

**Serie 3:**  
 9.8 ↗                      9.7 ↑                      9.0 →                      10.7 \*                      10.0 ↗  
 10.1 ↘                      10.3 \*                      10.3 \*                      10.2 \*                      10.6 \*  
 beste Teiler: 54.3 (24.), 96.9 (30.), 168.0 (27.)  
 Trefferlage: 0.98 mm rechts, 0.97 mm hoch  
 Streuwert: 1.60, horizontal: 1.78, vertikal: 1.40

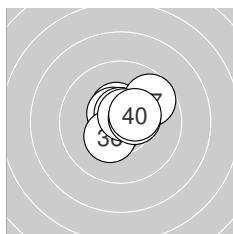

**Serie 4:**  
 10.5 \*                      10.5 \*                      10.8 \*                      10.6 \*                      10.7 \*  
 10.3 \*                      9.7 ↗                      10.7 \*                      10.5 \*                      10.4 \*  
 beste Teiler: 45.4 (33.), 66.7 (38.), 73.0 (35.)  
 Trefferlage: 0.39 mm rechts, 0.49 mm hoch  
 Streuwert: 0.96, horizontal: 1.07, vertikal: 0.83





Ergebnis: **391.0** (374)  
 Serien: 98.5 95.1 98.6 98.8  
 Zähler: 18 18 4 0 0 0 0 0 0 0  
 Innenzehner: 10  
 Weitestе: 618 (35.), 563 (20.), 549 (8.)  
 beste Teiler: 73.3 (2.), 86.8 (26.), 99.3 (39.)  
 Trefferlage: 0.76 mm links, 0.35 mm tief  
 Streuwert: 2.28, horizontal: 2.54, vertikal: 1.97

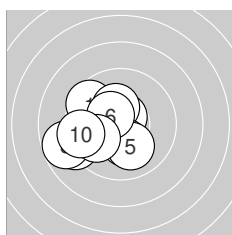
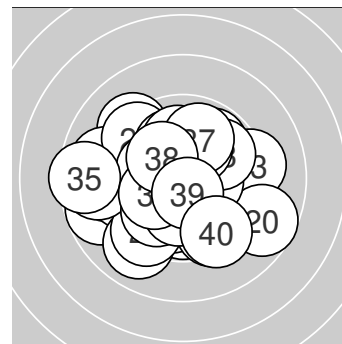

**Serie 1:**  
 9.6 ↘                      10.7 \*                      10.3 \*                      10.2 \*                      10.1 ↘  
 10.4 \*                      9.1 ↙                      8.8 ↙                      9.9 ↙                      9.4 ↙  
 beste Teiler: 73.3 (2.), 126.8 (6.), 165.5 (3.)  
 Trefferlage: 1.81 mm links, 0.49 mm tief  
 Streuwert: 1.89, horizontal: 2.15, vertikal: 1.58

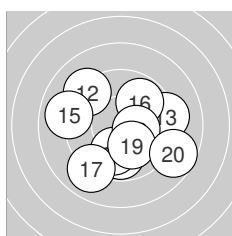

**Serie 2:**  
 9.8 ↓                      9.2 ↘                      9.2 →                      9.9 ↓                      9.0 ↙  
 9.8 ↗                      9.0 ↙                      10.4 \*                      10.1 ↘                      8.7 ↘  
 beste Teiler: 150.8 (18.), 213.9 (19.), 251.7 (14.)  
 Trefferlage: 0.21 mm rechts, 0.71 mm tief  
 Streuwert: 2.81, horizontal: 3.17, vertikal: 2.41

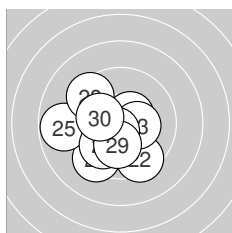

**Serie 3:**  
 10.5 \*                      9.5 ↘                      10.3 \*                      9.4 ↙                      8.8 ↙  
 10.6 \*                      9.9 ↙                      9.4 ↘                      10.1 ↓                      10.1 ↙  
 beste Teiler: 86.8 (26.), 115.2 (21.), 156.4 (23.)  
 Trefferlage: 1.05 mm links, 0.81 mm tief  
 Streuwert: 2.04, horizontal: 2.21, vertikal: 1.86

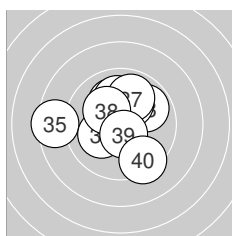

**Serie 4:**  
 10.1 ↖                      10.0 ↑                      9.9 ↗                      10.1 ↗                      8.5 ↙  
 10.1 ↙                      9.9 ↗                      10.2 \*                      10.6 \*                      9.4 ↘  
 beste Teiler: 99.3 (39.), 184.5 (38.), 203.1 (36.)  
 Trefferlage: 0.39 mm links, 0.63 mm hoch  
 Streuwert: 2.19, horizontal: 2.44, vertikal: 1.90



Ergebnis: **381.4** (364)  
 Serien: 95.4 92.2 96.9 96.9  
 Zähler: 13 18 9 0 0 0 0 0 0  
 Innenzehner: 6  
 Weitester: 730 (12.), 712 (19.), 658 (11.)  
 beste Teiler: 26.5 (15.), 90.6 (26.), 124.8 (33.)  
 Trefferlage: 1.57 mm links, 0.09 mm tief  
 Streuwert: 2.60, horizontal: 3.01, vertikal: 2.10

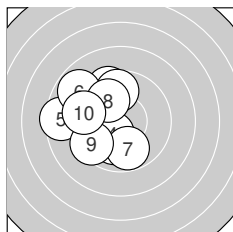
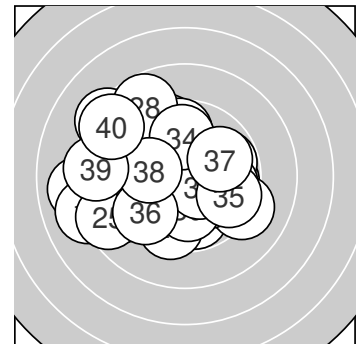

**Serie 1:**  
 9.5 ↗ 9.7 ↑ 10.0 ↓ 10.3 \* 8.5 ←  
 8.8 ↘ 9.8 ↓ 10.0 ↖ 9.4 ↙ 9.4 ↘  
 beste Teiler: 151.4 (4.), 234.6 (3.), 250.3 (8.)  
 Trefferlage: 2.10 mm links, 0.43 mm hoch  
 Streuwert: 2.30, horizontal: 2.13, vertikal: 2.46

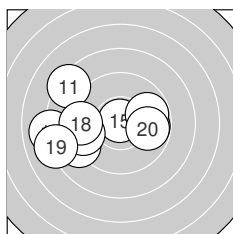

**Serie 2:**  
 8.3 ↘ 8.0 ← 9.8 → 9.0 ← 10.8 \*  
 9.3 ← 9.8 → 9.3 ← 8.1 ← 9.8 →  
 beste Teiler: 26.5 (15.), 285.3 (20.), 288.4 (17.)  
 Trefferlage: 2.32 mm links, 0.26 mm tief  
 Streuwert: 3.12, horizontal: 4.03, vertikal: 1.78

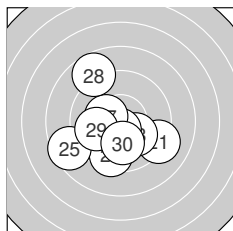

**Serie 3:**  
 9.2 ↘ 10.0 ← 10.1 ↘ 9.5 ↓ 8.6 ←  
 10.6 \* 10.3 \* 8.7 ↖ 9.9 ← 10.0 ↓  
 beste Teiler: 90.6 (26.), 158.1 (27.), 209.0 (23.)  
 Trefferlage: 0.96 mm links, 0.97 mm tief  
 Streuwert: 2.44, horizontal: 2.55, vertikal: 2.32

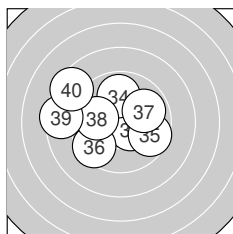

**Serie 4:**  
 10.1 → 10.4 \* 10.5 \* 9.9 ↑ 9.6 →  
 9.5 ↙ 9.9 ↗ 10.0 ← 8.5 ← 8.5 ↘  
 beste Teiler: 124.8 (33.), 150.2 (32.), 225.9 (31.)  
 Trefferlage: 0.92 mm links, 0.41 mm hoch  
 Streuwert: 2.57, horizontal: 3.19, vertikal: 1.76



Ergebnis: **332.1** (314)  
 Serien: 77.4 76.0 89.9 88.8  
 Zähler: 4 12 12 6 3 1 0 1 1 0  
 Innenzehner: 2  
 Weitester: 2189 (3.), 1874 (17.), 1316 (14.)  
 beste Teiler: 21.2 (36.), 80.7 (5.), 220.6 (30.)  
 Trefferlage: 3.90 mm links, 1.74 mm tief  
 Streuwert: 4.74, horizontal: 5.23, vertikal: 4.20

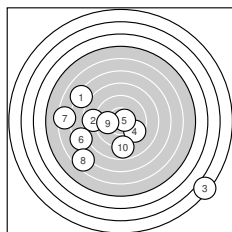
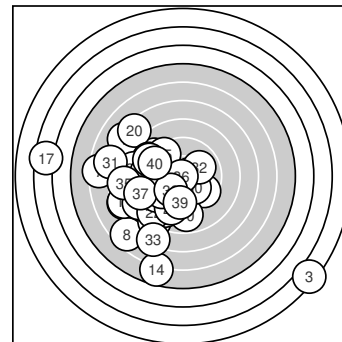

**Serie 1:**  
 7.2 ↘ 8.7 ← 2.2 ↘ 9.6 ↘ 10.6 \*  
 7.4 ← 6.4 ← 6.6 ↗ 9.9 ← 8.8 ↓  
 beste Teiler: 80.7 (5.), 263.4 (9.), 350.9 (4.)  
 Trefferlage: 2.19 mm links, 2.65 mm tief  
 Streuwert: 6.90, horizontal: 8.22, vertikal: 5.25

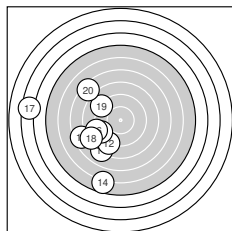

**Serie 2:**  
 8.1 ↙ 8.8 ↙ 7.5 ← 5.7 ↓ 9.1 ↙  
 8.8 ← 3.5 ← 8.2 ↗ 9.0 ↘ 7.3 ↘  
 beste Teiler: 455.7 (15.), 485.8 (19.), 526.4 (12.)  
 Trefferlage: 6.17 mm links, 2.34 mm tief  
 Streuwert: 4.99, horizontal: 4.66, vertikal: 5.30

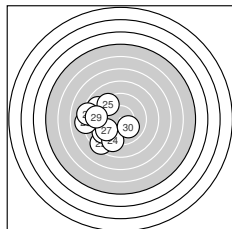

**Serie 3:**  
 8.9 ↘ 8.4 ↗ 9.2 ↗ 9.1 ↓ 9.4 ↘  
 8.1 ← 9.5 ↗ 8.2 ← 9.0 ← 10.1 ↘  
 beste Teiler: 220.6 (30.), 357.2 (27.), 392.9 (25.)  
 Trefferlage: 3.63 mm links, 0.93 mm tief  
 Streuwert: 2.59, horizontal: 2.52, vertikal: 2.67

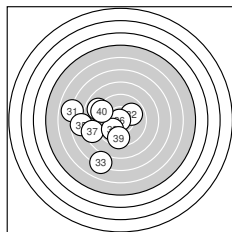

**Serie 4:**  
 6.9 ← 9.9 ↗ 7.2 ↓ 8.9 ↘ 7.7 ←  
 10.9 \* 8.5 ← 10.0 ↗ 9.5 ↓ 9.3 ↘  
 beste Teiler: 21.2 (36.), 249.3 (38.), 251.4 (32.)  
 Trefferlage: 3.60 mm links, 1.01 mm tief  
 Streuwert: 3.52, horizontal: 3.70, vertikal: 3.32



Ergebnis: **391.8** (374)  
 Serien: 96.0 100.2 96.9 98.7  
 Zähler: 20 15 4 1 0 0 0 0 0 0  
 Innenzehner: 13  
 Weitester: 772 (2.), 633 (8.), 573 (26.)  
 beste Teiler: 33.2 (32.), 62.3 (7.), 75.6 (4.)  
 Trefferlage: 1.16 mm links, 0.40 mm hoch  
 Streuwert: 2.21, horizontal: 2.49, vertikal: 1.90

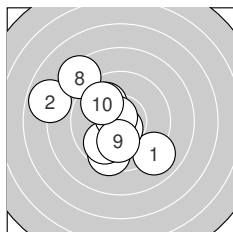
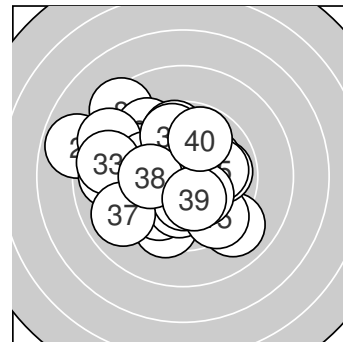

**Serie 1:**  
 9.0 ↘                      7.9 ←                      9.5 ↓                      10.7 \*                      9.8 ↙  
 10.0 ↘                      10.7 \*                      8.4 ↘                      10.1 ↓                      9.9 ↘  
 beste Teiler: 62.3 (7.), 75.6 (4.), 208.6 (9.)  
 Trefferlage: 1.52 mm links, 0.10 mm tief  
 Streuwert: 2.79, horizontal: 2.86, vertikal: 2.72

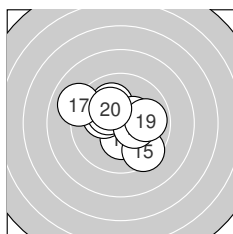

**Serie 2:**  
 10.3 \*                      10.2 \*                      10.1 ↖                      10.4 \*                      9.5 ↘  
 10.3 \*                      9.0 ←                      10.3 \*                      9.9 →                      10.2 \*  
 beste Teiler: 142.8 (14.), 151.1 (18.), 157.2 (11.)  
 Trefferlage: 0.16 mm links, 0.32 mm hoch  
 Streuwert: 1.88, horizontal: 2.17, vertikal: 1.55

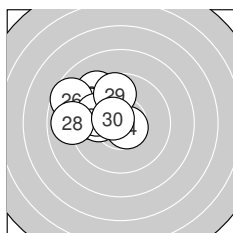

**Serie 3:**  
 9.3 ↘                      9.6 ←                      9.6 ←                      10.6 \*                      10.0 ←  
 8.7 ↘                      9.9 ←                      8.9 ←                      9.7 ↑                      10.6 \*  
 beste Teiler: 79.0 (24.), 94.1 (30.), 230.8 (25.)  
 Trefferlage: 2.48 mm links, 1.20 mm hoch  
 Streuwert: 1.61, horizontal: 1.87, vertikal: 1.31

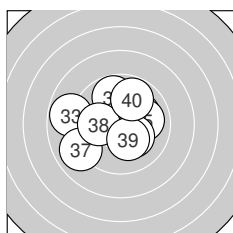

**Serie 4:**  
 9.8 ↑                      10.8 \*                      8.8 ←                      10.1 ↗                      10.0 →  
 10.2 \*                      9.0 ↙                      10.0 ←                      10.2 \*                      9.8 ↗  
 beste Teiler: 33.2 (32.), 176.6 (39.), 183.8 (36.)  
 Trefferlage: 0.49 mm links, 0.20 mm hoch  
 Streuwert: 2.22, horizontal: 2.61, vertikal: 1.76



Ergebnis: **302.9** (286)  
 Serien: 74.6 71.4 83.0 73.9  
 Zähler: 3 4 13 7 7 3 2 0 1 0  
 Innenzehner: 1  
 Weitester: 2165 (11.), 1576 (33.), 1529 (14.)  
 beste Teiler: 68.0 (35.), 203.8 (38.), 244.0 (30.)  
 Trefferlage: 1.99 mm rechts, 1.46 mm tief  
 Streuwert: 6.52, horizontal: 6.92, vertikal: 6.09

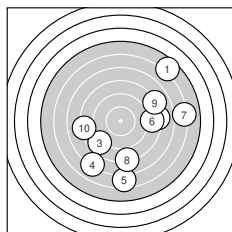
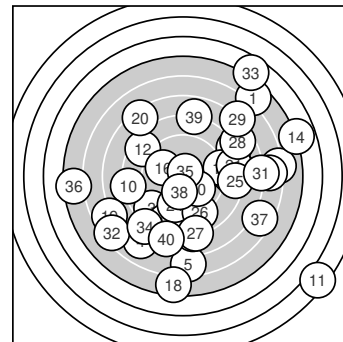

**Serie 1:**  
 5.6 ↗ 8.1 → 8.7 ↙ 7.0 ↙ 6.5 ↓  
 8.5 → 6.1 → 8.0 ↓ 8.0 ↗ 8.1 ←  
 beste Teiler: 569.9 (3.), 602.1 (6.), 708.2 (10.)  
 Trefferlage: 2.63 mm rechts, 1.63 mm tief  
 Streuwert: 6.39, horizontal: 6.52, vertikal: 6.26

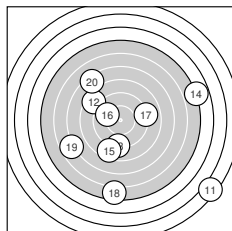

**Serie 2:**  
 2.3 ↘ 8.5 ↘ 9.0 ↓ 4.8 → 8.5 ↓  
 9.9 ↖ 9.0 → 5.4 ↓ 6.7 ↙ 7.3 ↖  
 beste Teiler: 275.0 (16.), 487.6 (13.), 494.7 (17.)  
 Trefferlage: 1.00 mm rechts, 2.46 mm tief  
 Streuwert: 8.01, horizontal: 8.64, vertikal: 7.32

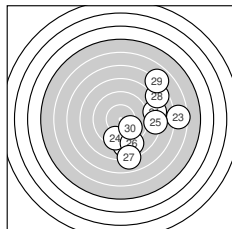

**Serie 3:**  
 8.3 → 8.9 ↓ 6.5 → 9.5 ↓ 8.3 →  
 8.9 ↘ 8.0 ↓ 7.7 ↗ 6.9 ↗ 10.0 ↘  
 beste Teiler: 244.0 (30.), 375.8 (24.), 504.9 (22.)  
 Trefferlage: 4.34 mm rechts, 0.91 mm tief  
 Streuwert: 4.14, horizontal: 3.77, vertikal: 4.49

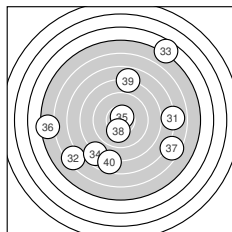

**Serie 4:**  
 7.0 → 6.3 ↙ 4.6 ↗ 7.7 ↙ 10.7 \*  
 5.4 ← 6.5 ↘ 10.1 ↓ 7.9 ↑ 7.7 ↓  
 beste Teiler: 68.0 (35.), 203.8 (38.), 770.2 (39.)  
 Trefferlage: 0.02 mm links, 0.84 mm tief  
 Streuwert: 7.42, horizontal: 7.99, vertikal: 6.79



Ergebnis: **407.0** (387)  
 Serien: 98.4 104.2 101.0 103.4  
 Zähler: 27 13 0 0 0 0 0 0 0 0  
 Innenzehner: 22  
 Weitester: 498 (10.), 445 (27.), 361 (29.)  
 beste Teiler: 17.2 (25.), 19.8 (21.), 37.5 (38.)  
 Trefferlage: 0.09 mm rechts, 0.39 mm hoch  
 Streuwert: 1.58, horizontal: 1.73, vertikal: 1.42

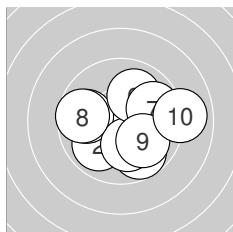
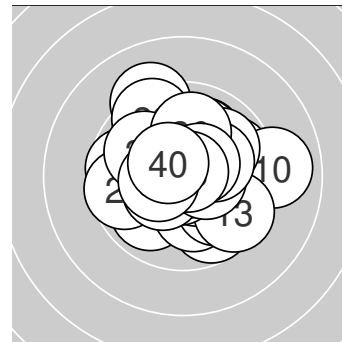

**Serie 1:**  
 9.7 ↘                      9.9 ↗                      10.4 \*                      9.8 ←                      10.1 ↓  
 10.0 ↑                      9.8 →                      9.7 ←                      10.0 ↘                      9.0 →  
 beste Teiler: 149.2 (3.), 203.4 (5.), 239.3 (6.)  
 Trefferlage: 0.58 mm rechts, 0.47 mm tief  
 Streuwert: 2.11, horizontal: 2.54, vertikal: 1.56

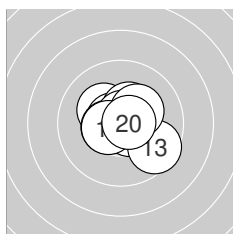

**Serie 2:**  
 10.2 \*                      10.6 \*                      9.6 ↘                      10.7 \*                      10.4 \*  
 10.5 \*                      10.7 \*                      10.3 \*                      10.5 \*                      10.7 \*  
 beste Teiler: 53.1 (17.), 68.8 (14.), 69.3 (20.)  
 Trefferlage: 0.24 mm rechts, 0.10 mm hoch  
 Streuwert: 1.15, horizontal: 1.31, vertikal: 0.96

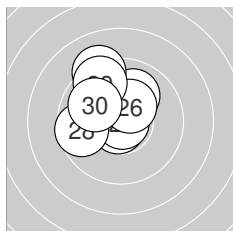

**Serie 3:**  
 10.9 \*                      10.0 ↑                      9.9 ↘                      10.7 \*                      10.9 \*  
 10.4 \*                      9.2 ↘                      9.6 ←                      9.5 ↘                      9.9 ↘  
 beste Teiler: 17.2 (25.), 19.8 (21.), 52.8 (24.)  
 Trefferlage: 0.87 mm links, 1.29 mm hoch  
 Streuwert: 1.50, horizontal: 1.39, vertikal: 1.60

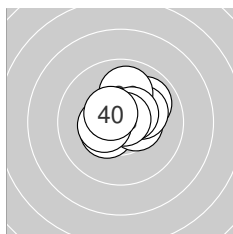

**Serie 4:**  
 10.3 \*                      9.9 ↗                      10.4 \*                      10.4 \*                      10.2 \*  
 10.0 ↑                      10.5 \*                      10.8 \*                      10.4 \*                      10.5 \*  
 beste Teiler: 37.5 (38.), 109.7 (40.), 115.0 (37.)  
 Trefferlage: 0.42 mm rechts, 0.65 mm hoch  
 Streuwert: 1.07, horizontal: 1.18, vertikal: 0.94



Ergebnis: **389.3** (369)  
 Serien: 92.0 101.5 96.0 99.8  
 Zähler: 17 17 4 2 0 0 0 0 0 0  
 Innenzehner: 11  
 Weitester: 968 (2.), 804 (23.), 664 (9.)  
 beste Teiler: 55.1 (15.), 66.8 (20.), 74.0 (18.)  
 Trefferlage: 0.29 mm links, 0.46 mm hoch  
 Streuwert: 2.54, horizontal: 2.74, vertikal: 2.32

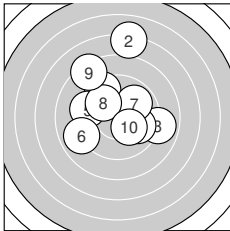
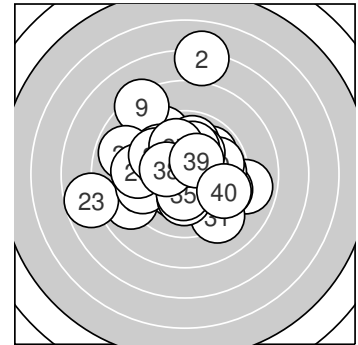

**Serie 1:**

9.4 ↘	7.1 ↑	8.9 →	9.9 →	9.4 ←
8.9 ↙	9.9 ↗	10.0 ↘	8.3 ↘	10.2 *

beste Teiler: 187.8 (10.), 250.3 (8.), 269.6 (7.)  
 Trefferlage: 0.29 mm links, 1.74 mm hoch  
 Streuwert: 3.43, horizontal: 3.19, vertikal: 3.65

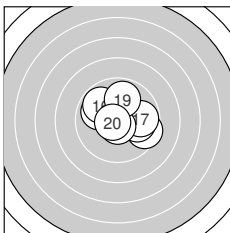

**Serie 2:**

9.5 →	10.5 *	9.9 ↘	10.0 →	10.7 *
9.8 ↘	9.8 →	10.7 *	9.9 ↑	10.7 *

beste Teiler: 55.1 (15.), 66.8 (20.), 74.0 (18.)  
 Trefferlage: 0.49 mm rechts, 0.27 mm hoch  
 Streuwert: 1.63, horizontal: 1.97, vertikal: 1.20

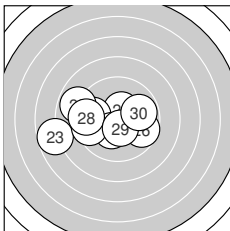

**Serie 3:**

10.5 *	9.7 ←	7.7 ←	10.3 *	8.9 ←
9.7 →	9.5 ←	9.4 ←	10.5 *	9.8 →

beste Teiler: 117.3 (29.), 124.2 (21.), 161.4 (24.)  
 Trefferlage: 1.74 mm links, 0.25 mm tief  
 Streuwert: 2.61, horizontal: 3.46, vertikal: 1.31

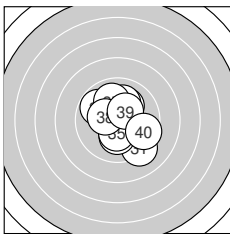

**Serie 4:**

9.2 ↘	9.8 ↘	10.1 ↓	10.1 ↗	10.3 *
10.1 ↑	10.0 ↘	10.3 *	10.4 *	9.5 →

beste Teiler: 147.5 (39.), 157.1 (38.), 159.4 (35.)  
 Trefferlage: 0.37 mm rechts, 0.08 mm hoch  
 Streuwert: 1.90, horizontal: 1.75, vertikal: 2.04



Ergebnis: **331.2** (312)  
 Serien: 79.1 78.5 85.9 87.7  
 Zähler: 6 10 10 5 4 4 0 1 0 0  
 Innenzehner: 4  
 Weitester: 1904 (12.), 1359 (1.), 1332 (7.)  
 beste Teiler: 29.9 (3.), 128.4 (34.), 132.3 (31.)  
 Trefferlage: 0.89 mm rechts, 0.05 mm tief  
 Streuwert: 5.56, horizontal: 5.70, vertikal: 5.42

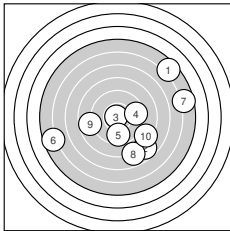
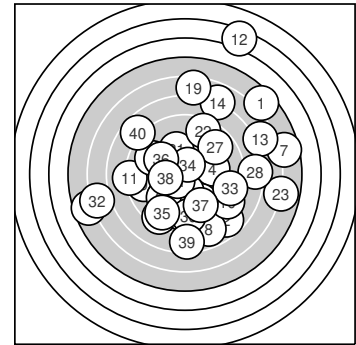

**Serie 1:**

5.5 ↗	7.7 ↘	10.8 *	9.5 →	9.6 ↓
5.6 ←	5.6 →	7.8 ↘	8.7 ←	8.3 ↘

beste Teiler: 29.9 (3.), 341.2 (5.), 366.9 (4.)  
 Trefferlage: 2.24 mm rechts, 1.25 mm tief  
 Streuwert: 6.23, horizontal: 7.34, vertikal: 4.86

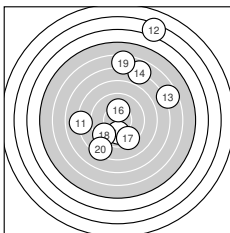

**Serie 2:**

8.1 ←	3.3 ↗	6.6 ↗	6.8 ↗	10.0 ↓
10.2 *	9.3 ↘	9.4 ↗	6.4 ↑	8.4 ↗

beste Teiler: 193.5 (16.), 243.2 (15.), 386.9 (18.)  
 Trefferlage: 1.13 mm rechts, 3.00 mm hoch  
 Streuwert: 6.44, horizontal: 5.03, vertikal: 7.59

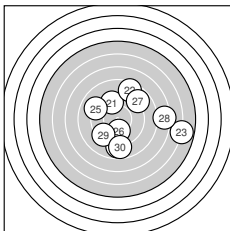

**Serie 3:**

9.6 ↖	8.5 ↗	5.8 →	8.8 ↓	9.0 ↖
10.0 ↓	8.8 ↗	7.3 →	9.3 ↗	8.8 ↓

beste Teiler: 227.0 (26.), 344.7 (21.), 411.9 (29.)  
 Trefferlage: 2.05 mm rechts, 0.37 mm tief  
 Streuwert: 4.63, horizontal: 5.25, vertikal: 3.90

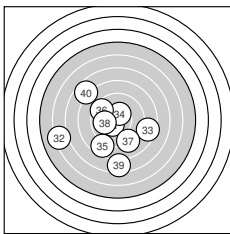

**Serie 4:**

10.4 *	6.2 ←	8.5 →	10.4 *	8.6 ↗
9.5 ↖	9.1 ↘	9.9 ←	7.4 ↓	7.7 ↖

beste Teiler: 128.4 (34.), 132.3 (31.), 257.1 (38.)  
 Trefferlage: 1.86 mm links, 1.59 mm tief  
 Streuwert: 4.37, horizontal: 4.71, vertikal: 4.01





Ergebnis: **368.6** (350)  
 Serien: 89.5 93.8 91.2 94.1  
 Zähler: 10 17 7 5 1 0 0 0 0 0  
 Innenzehner: 7  
 Weitester: 1143 (10.), 959 (40.), 940 (6.)  
 beste Teiler: 86.6 (5.), 87.9 (31.), 119.6 (16.)  
 Trefferlage: 0.58 mm links, 0.86 mm hoch  
 Streuwert: 3.52, horizontal: 4.17, vertikal: 2.74

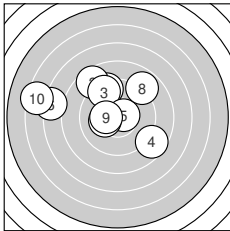
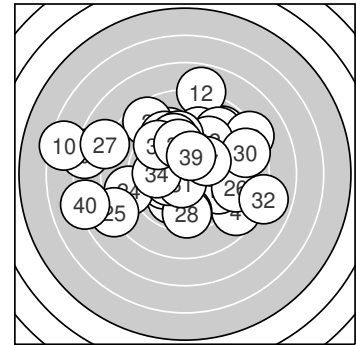

**Serie 1:**

9.3 ↖	8.6 ↖	9.4 ↖	8.6 ↘	10.6 *
7.2 ↙	10.2 *	8.9 ↗	10.3 *	6.4 ↖

beste Teiler: 86.6 (5.), 159.0 (9.), 181.4 (7.)  
 Trefferlage: 2.16 mm links, 1.71 mm hoch  
 Streuwert: 3.94, horizontal: 4.94, vertikal: 2.57

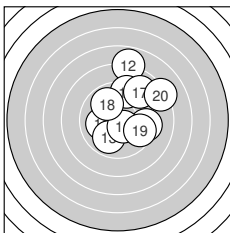

**Serie 2:**

10.1 ↖	7.9 ↑	9.9 ↘	9.4 →	9.3 ↑
10.5 *	9.0 ↗	9.9 ↖	9.6 ↘	8.2 ↗

beste Teiler: 119.6 (16.), 220.2 (11.), 261.1 (13.)  
 Trefferlage: 1.47 mm rechts, 1.53 mm hoch  
 Streuwert: 2.89, horizontal: 2.59, vertikal: 3.16

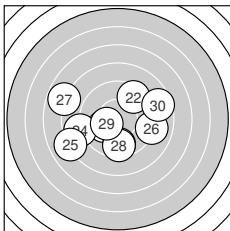

**Serie 3:**

10.1 ↖	9.5 ↗	9.6 ↓	8.8 ↖	8.0 ↖
9.0 →	7.8 ↖	9.5 ↓	10.3 *	8.6 →

beste Teiler: 162.3 (29.), 210.2 (21.), 343.6 (23.)  
 Trefferlage: 0.95 mm links, 0.70 mm tief  
 Streuwert: 3.62, horizontal: 4.45, vertikal: 2.54

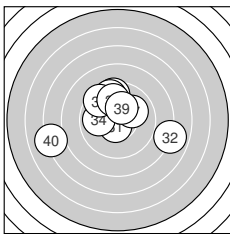

**Serie 4:**

10.6 *	7.9 →	9.5 ↑	9.9 ↖	9.6 ↑
9.5 ↖	10.0 ↗	9.8 ↑	10.2 *	7.1 ↖

beste Teiler: 87.9 (31.), 177.0 (39.), 231.0 (37.)  
 Trefferlage: 0.69 mm links, 0.93 mm hoch  
 Streuwert: 3.32, horizontal: 4.09, vertikal: 2.31



Ergebnis: **368.0** (351)  
 Serien: 94.5 93.0 90.0 90.5  
 Zähler: 11 15 9 4 1 0 0 0 0 0  
 Innenzehner: 10  
 Weitestе: 1077 (36.), 930 (24.), 829 (25.)  
 beste Teiler: 37.4 (8.), 107.0 (15.), 125.3 (7.)  
 Trefferlage: 2.04 mm rechts, 0.02 mm hoch  
 Streuwert: 3.28, horizontal: 3.96, vertikal: 2.43

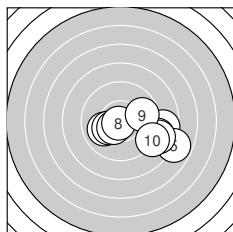
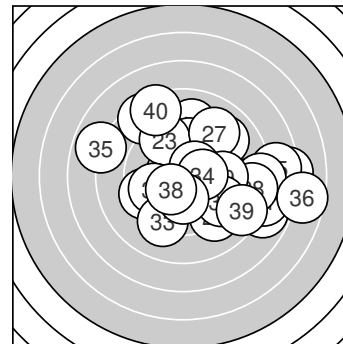

**Serie 1:**

8.7 →	10.0 ←	8.9 →	10.2 *	7.8 →
8.8 →	10.5 *	10.8 *	9.8 →	9.0 →

beste Teiler: 37.4 (8.), 125.3 (7.), 180.8 (4.)  
 Trefferlage: 2.48 mm rechts, 1.24 mm tief  
 Streuwert: 2.55, horizontal: 3.41, vertikal: 1.18

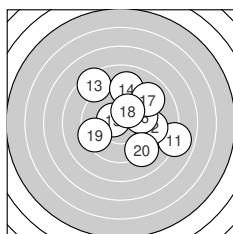

**Serie 2:**

8.0 →	9.3 →	8.5 ↘	9.1 ↑	10.5 *
9.8 →	9.0 ↗	10.2 *	9.4 ←	9.2 ↘

beste Teiler: 107.0 (15.), 189.5 (18.), 283.9 (16.)  
 Trefferlage: 1.41 mm rechts, 0.79 mm hoch  
 Streuwert: 3.14, horizontal: 3.38, vertikal: 2.87

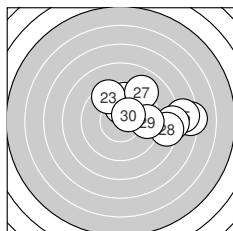

**Serie 3:**

10.2 *	9.8 ↑	9.5 ↘	7.2 →	7.6 →
8.2 →	9.1 ↗	8.5 →	9.5 →	10.4 *

beste Teiler: 134.3 (30.), 187.2 (21.), 296.9 (22.)  
 Trefferlage: 3.69 mm rechts, 1.24 mm hoch  
 Streuwert: 2.91, horizontal: 3.76, vertikal: 1.65

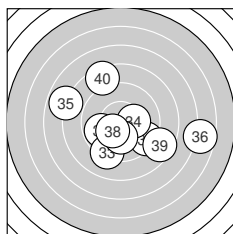

**Serie 4:**

9.3 ↘	9.8 ←	9.2 ↓	10.3 *	7.9 ←
6.6 →	10.2 *	10.3 *	8.5 ↘	8.4 ↘

beste Teiler: 157.8 (38.), 174.4 (34.), 200.0 (37.)  
 Trefferlage: 0.58 mm rechts, 0.69 mm tief  
 Streuwert: 4.06, horizontal: 4.95, vertikal: 2.91



Ergebnis: **365.1** (350)  
 Serien: 100.4 87.6 84.1 93.0  
 Zähler: 11 15 8 5 1 0 0 0 0 0  
 Innenzehner: 6  
 Weitester: 1097 (30.), 990 (21.), 979 (12.)  
 beste Teiler: 101.8 (9.), 154.3 (8.), 163.2 (7.)  
 Trefferlage: 0.87 mm rechts, 0.73 mm tief  
 Streuwert: 3.71, horizontal: 4.30, vertikal: 3.00

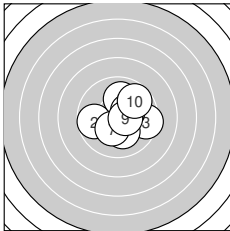
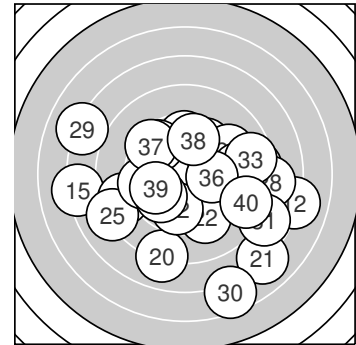

**Serie 1:**

10.1 ↗	9.7 ←	9.5 →	10.1 ↗	10.0 ↑
10.2 *	10.3 *	10.3 *	10.5 *	9.7 ↗

beste Teiler: 101.8 (9.), 154.3 (8.), 163.2 (7.)  
 Trefferlage: 0.81 mm rechts, 0.40 mm hoch  
 Streuwert: 1.65, horizontal: 1.77, vertikal: 1.53

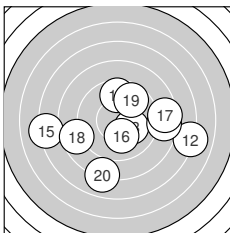

**Serie 2:**

9.7 ↑	7.0 →	10.2 *	8.5 →	7.2 ←
10.1 ↓	8.5 →	8.7 ←	9.7 ↗	8.0 ↓

beste Teiler: 200.8 (13.), 209.3 (16.), 315.6 (19.)  
 Trefferlage: 0.90 mm rechts, 0.99 mm tief  
 Streuwert: 4.46, horizontal: 5.59, vertikal: 2.91

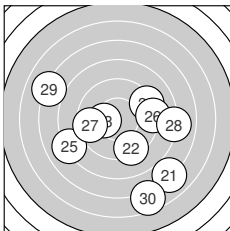

**Serie 3:**

7.0 ↘	9.3 ↓	10.2 *	9.2 ↗	8.1 ←
9.1 →	9.5 ←	8.0 →	7.1 ↖	6.6 ↓

beste Teiler: 176.9 (23.), 366.1 (27.), 412.9 (22.)  
 Trefferlage: 0.75 mm rechts, 1.99 mm tief  
 Streuwert: 4.99, horizontal: 5.60, vertikal: 4.29

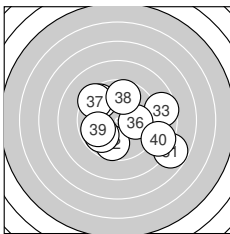

**Serie 4:**

7.8 ↘	9.7 ↓	8.6 →	9.6 ↘	9.8 ↙
10.0 →	9.4 ↖	9.7 ↑	9.8 ←	8.6 →

beste Teiler: 235.1 (36.), 280.4 (39.), 283.6 (35.)  
 Trefferlage: 1.03 mm rechts, 0.34 mm tief  
 Streuwert: 3.22, horizontal: 3.78, vertikal: 2.53



Ergebnis: **334.4** (316)  
 Serien: 81.6 78.9 87.5 86.4  
 Zähler: 5 10 10 11 1 2 0 1 0 0  
 Innenzehner: 4  
 Weitester: 1803 (20.), 1347 (9.), 1335 (40.)  
 beste Teiler: 100.4 (35.), 119.5 (1.), 143.1 (30.)  
 Trefferlage: 0.69 mm rechts, 3.50 mm hoch  
 Streuwert: 4.64, horizontal: 5.52, vertikal: 3.55

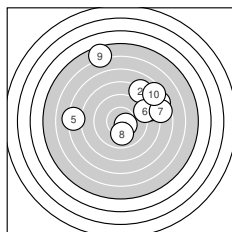
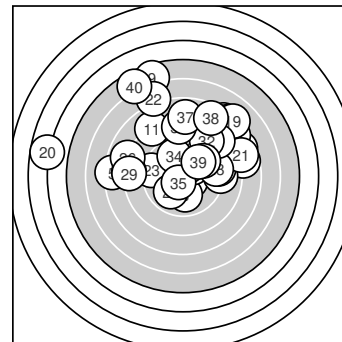

**Serie 1:**  
 10.5 \*                      8.1 ↗                      8.4 →                      7.6 →                      7.2 ←  
    8.9 →                      7.7 →                      10.0 ↓                      5.6 ↗                      7.6 ↗  
 beste Teiler: 119.5 (1.), 244.6 (8.), 520.3 (6.)  
 Trefferlage: 2.45 mm rechts, 3.14 mm hoch  
 Streuwert: 4.95, horizontal: 5.55, vertikal: 4.26

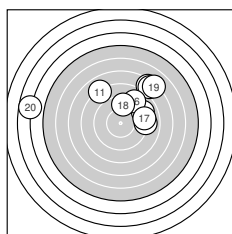

**Serie 2:**  
 8.0 ↘                      7.3 ↗                      9.0 →                      9.0 →                      7.3 ↗  
    8.9 ↗                      9.1 →                      9.5 ↑                      7.1 ↗                      3.7 ←  
 beste Teiler: 369.1 (18.), 475.7 (17.), 489.2 (14.)  
 Trefferlage: 1.27 mm rechts, 4.20 mm hoch  
 Streuwert: 5.55, horizontal: 7.38, vertikal: 2.68

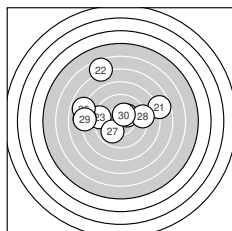

**Serie 3:**  
 7.7 →                      6.6 ↘                      9.3 ←                      10.3 \*                      8.1 ←  
    7.9 ←                      9.9 ↙                      9.2 →                      8.1 ←                      10.4 \*  
 beste Teiler: 143.1 (30.), 170.8 (24.), 257.6 (27.)  
 Trefferlage: 1.70 mm links, 1.83 mm hoch  
 Streuwert: 4.26, horizontal: 5.12, vertikal: 3.18

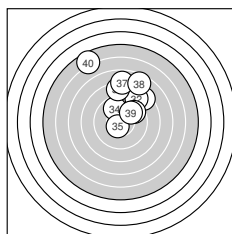

**Serie 4:**  
 8.4 ↗                      8.7 ↗                      9.6 ↗                      9.8 ↘                      10.6 \*  
    8.4 ↑                      7.9 ↑                      7.6 ↗                      9.8 ↗                      5.6 ↘  
 beste Teiler: 100.4 (35.), 276.0 (39.), 288.0 (34.)  
 Trefferlage: 0.77 mm rechts, 4.84 mm hoch  
 Streuwert: 3.43, horizontal: 3.19, vertikal: 3.65



Ergebnis: **384.0** (368)  
 Serien: 95.2 95.4 96.4 97.0  
 Zähler: 13 22 5 0 0 0 0 0 0 0  
 Innenzehner: 9  
 Weitester: 738 (15.), 564 (13.), 538 (29.)  
 beste Teiler: 42.4 (34.), 62.2 (3.), 91.5 (11.)  
 Trefferlage: 0.15 mm links, 0.21 mm tief  
 Streuwert: 2.66, horizontal: 2.74, vertikal: 2.57

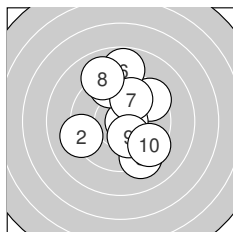
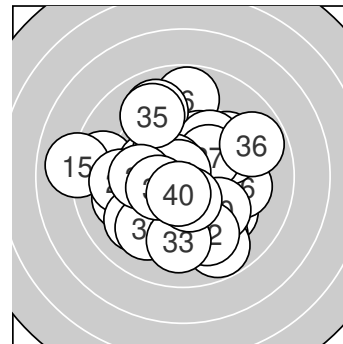

**Serie 1:**

9.4 ↗	9.2 ←	10.7 *	9.4 ↑	9.2 ↓
8.8 ↑	9.9 ↗	9.0 ↑	10.2 *	9.4 ↓

beste Teiler: 62.2 (3.), 178.0 (9.), 256.2 (7.)  
 Trefferlage: 0.39 mm rechts, 0.86 mm hoch  
 Streuwert: 2.74, horizontal: 2.23, vertikal: 3.16

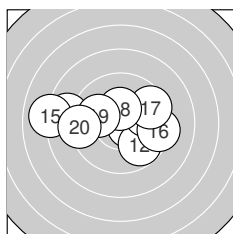

**Serie 2:**

10.6 *	9.8 ↘	8.7 ←	9.9 →	8.0 ←
9.3 →	9.5 ↗	10.4 *	10.0 ←	9.2 ←

beste Teiler: 91.5 (11.), 150.1 (18.), 244.4 (19.)  
 Trefferlage: 0.70 mm links, 0.27 mm hoch  
 Streuwert: 2.92, horizontal: 3.96, vertikal: 1.18

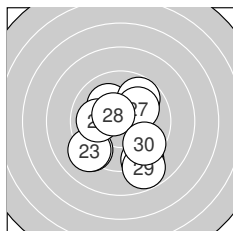

**Serie 3:**

10.1 ↘	9.2 ↙	9.2 ↙	9.8 ↗	10.0 ←
9.1 ↘	10.1 ↗	10.5 *	8.8 ↘	9.6 ↘

beste Teiler: 104.0 (28.), 210.6 (21.), 223.0 (27.)  
 Trefferlage: 0.00 mm, 1.10 mm tief  
 Streuwert: 2.51, horizontal: 2.40, vertikal: 2.61

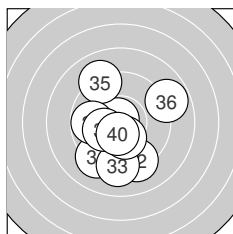

**Serie 4:**

9.2 ↙	9.2 ↘	9.2 ↓	10.8 *	9.1 ↘
8.8 ↗	9.8 ←	10.3 *	10.2 *	10.4 *

beste Teiler: 42.4 (34.), 126.8 (40.), 169.3 (38.)  
 Trefferlage: 0.32 mm links, 0.90 mm tief  
 Streuwert: 2.54, horizontal: 2.30, vertikal: 2.75



Ergebnis: **389.8** (373)  
 Serien: 99.1 98.5 94.1 98.1  
 Zähler: 18 17 5 0 0 0 0 0 0 0  
 Innenzehner: 11  
 Weitestе: 621 (3.), 574 (39.), 566 (24.)  
 beste Teiler: 23.4 (37.), 37.1 (2.), 67.1 (1.)  
 Trefferlage: 0.62 mm links, 0.63 mm hoch  
 Streuwert: 2.36, horizontal: 2.51, vertikal: 2.20

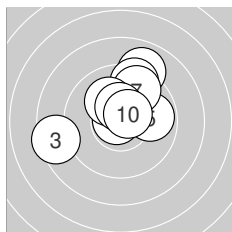
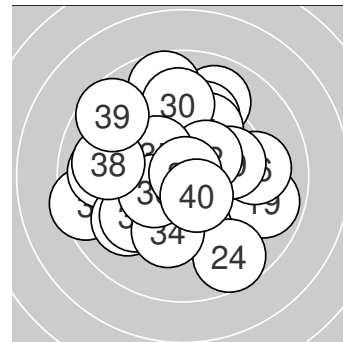

**Serie 1:**  
 10.7 \*                      10.8 \*                      8.5 ←                      9.0 ↑                      9.9 →  
 9.4 ↑                      9.7 ↑                      10.1 ↘                      10.4 \*                      10.6 \*  
 beste Teiler: 37.1 (2.), 67.1 (1.), 95.4 (10.)  
 Trefferlage: 0.05 mm rechts, 1.43 mm hoch  
 Streuwert: 2.15, horizontal: 2.41, vertikal: 1.84

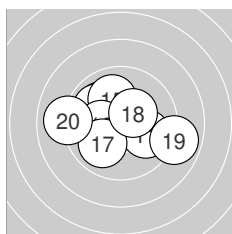

**Serie 2:**  
 9.9 →                      10.0 ↘                      10.2 \*                      9.9 ↖                      10.0 ↑  
 10.2 \*                      10.0 ↙                      10.4 \*                      8.9 →                      9.0 ←  
 beste Teiler: 148.5 (18.), 179.5 (16.), 193.1 (13.)  
 Trefferlage: 0.65 mm links, 0.21 mm hoch  
 Streuwert: 2.18, horizontal: 2.76, vertikal: 1.37

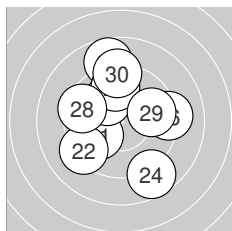

**Serie 3:**  
 10.0 ↙                      9.2 ↙                      8.7 ↑                      8.7 ↘                      10.1 ↘  
 9.2 →                      9.7 ↑                      9.5 ↖                      9.8 →                      9.2 ↑  
 beste Teiler: 222.4 (25.), 237.6 (21.), 297.5 (29.)  
 Trefferlage: 0.19 mm links, 0.85 mm hoch  
 Streuwert: 2.96, horizontal: 2.73, vertikal: 3.17

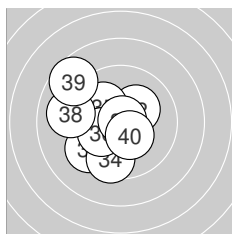

**Serie 4:**  
 9.5 ←                      10.2 \*                      9.4 ↙                      9.6 ↓                      10.1 ↘  
 10.2 \*                      10.9 \*                      9.1 ←                      8.7 ↖                      10.4 \*  
 beste Teiler: 23.4 (37.), 146.4 (40.), 184.5 (32.)  
 Trefferlage: 1.72 mm links, 0.02 mm hoch  
 Streuwert: 2.09, horizontal: 2.11, vertikal: 2.07



Ergebnis: **379.8** (362)  
 Serien: 96.1 96.8 92.0 94.9  
 Zähler: 9 25 5 1 0 0 0 0 0 0  
 Innenzehner: 7  
 Weitester: 808 (30.), 705 (31.), 702 (2.)  
 beste Teiler: 104.7 (18.), 105.0 (15.), 113.2 (10.)  
 Trefferlage: 0.10 mm links, 0.91 mm hoch  
 Streuwert: 2.78, horizontal: 3.07, vertikal: 2.46

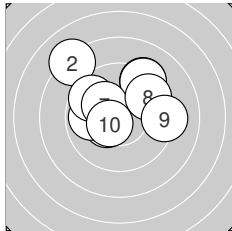
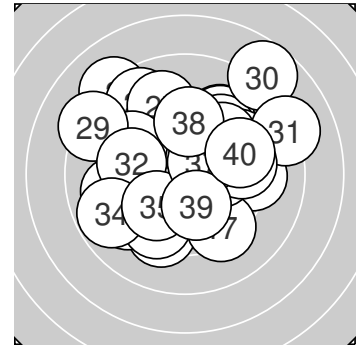

**Serie 1:**

9.3 ↗	8.1 ↘	10.4 *	9.3 ↗	9.9 ←
9.6 ↘	10.2 *	9.6 ↗	9.2 →	10.5 *

beste Teiler: 113.2 (10.), 141.9 (3.), 188.8 (7.)  
 Trefferlage: 0.19 mm links, 1.59 mm hoch  
 Streuwert: 2.51, horizontal: 2.92, vertikal: 2.03

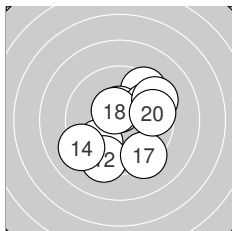

**Serie 2:**

9.8 ↗	9.3 ↓	9.5 ↗	9.1 ↖	10.5 *
9.8 ↗	9.3 ↘	10.5 *	9.4 ↗	9.6 →

beste Teiler: 104.7 (18.), 105.0 (15.), 288.9 (11.)  
 Trefferlage: 0.61 mm rechts, 0.30 mm tief  
 Streuwert: 2.45, horizontal: 2.49, vertikal: 2.42

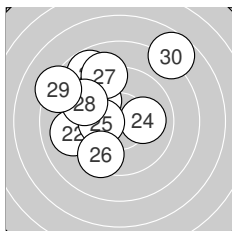

**Serie 3:**

9.8 ↘	9.1 ←	8.8 ↘	10.1 →	10.2 *
9.5 ↓	9.1 ↖	9.4 ↘	8.3 ↘	7.7 ↗

beste Teiler: 177.2 (25.), 225.1 (24.), 285.7 (21.)  
 Trefferlage: 1.65 mm links, 1.79 mm hoch  
 Streuwert: 3.06, horizontal: 3.18, vertikal: 2.93

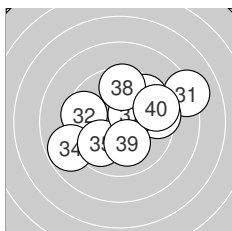

**Serie 4:**

8.1 ↗	9.5 ←	9.6 ↗	8.8 ↖	9.9 ↖
9.5 →	10.4 *	9.6 ↑	10.1 ↓	9.4 →

beste Teiler: 136.4 (37.), 213.8 (39.), 274.0 (35.)  
 Trefferlage: 0.82 mm rechts, 0.55 mm hoch  
 Streuwert: 2.85, horizontal: 3.44, vertikal: 2.10



Ergebnis: **357.1** (338)  
 Serien: 91.7 87.2 86.9 91.3  
 Zähler: 4 17 15 2 1 1 0 0 0 0  
 Innenzehner: 2  
 Weitester: 1370 (26.), 1116 (20.), 866 (2.)  
 beste Teiler: 69.9 (4.), 87.9 (31.), 202.3 (35.)  
 Trefferlage: 2.01 mm links, 0.56 mm tief  
 Streuwert: 3.77, horizontal: 4.57, vertikal: 2.74

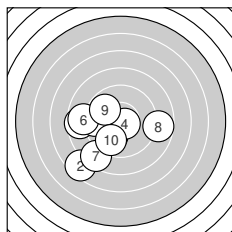
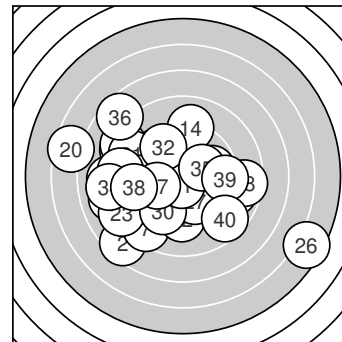

**Serie 1:**

10.0 ↙	7.5 ↙	8.6 ←	10.7 *	9.4 ←
8.8 ←	8.5 ↙	8.7 →	9.8 ↘	9.7 ↙

beste Teiler: 69.9 (4.), 242.1 (1.), 282.4 (9.)  
 Trefferlage: 2.32 mm links, 1.56 mm tief  
 Streuwert: 3.05, horizontal: 3.49, vertikal: 2.53

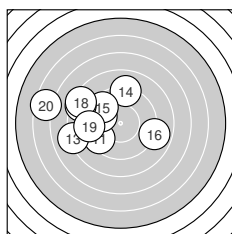

**Serie 2:**

9.4 ↙	9.8 ↘	8.1 ←	9.1 ↑	9.6 ↘
8.9 →	8.4 ↘	8.3 ↘	9.1 ←	6.5 ←

beste Teiler: 293.2 (12.), 348.4 (15.), 377.1 (11.)  
 Trefferlage: 3.66 mm links, 0.98 mm hoch  
 Streuwert: 3.50, horizontal: 4.31, vertikal: 2.44

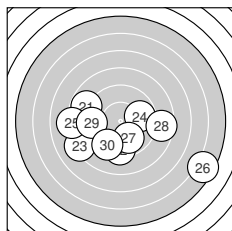

**Serie 3:**

8.8 ↘	9.3 ↓	8.2 ↙	9.8 →	8.1 ←
5.5 ↘	9.9 ↘	8.6 →	9.3 ←	9.4 ↙

beste Teiler: 268.3 (27.), 289.1 (24.), 391.8 (30.)  
 Trefferlage: 0.23 mm links, 1.84 mm tief  
 Streuwert: 4.60, horizontal: 5.95, vertikal: 2.65

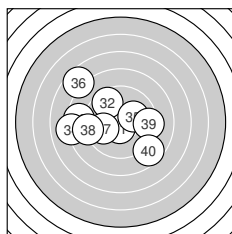

**Serie 4:**

10.6 *	9.6 ↘	8.5 ←	8.1 ←	10.1 →
7.6 ↘	9.9 ←	9.0 ←	9.3 →	8.6 ↘

beste Teiler: 87.9 (31.), 202.3 (35.), 266.7 (37.)  
 Trefferlage: 1.85 mm links, 0.16 mm hoch  
 Streuwert: 3.51, horizontal: 4.21, vertikal: 2.64





Ergebnis: **379.6** (358)  
 Serien: 93.6 94.0 99.4 92.6  
 Zähler: 10 20 8 2 0 0 0 0 0 0  
 Innenzehner: 6  
 Weitester: 785 (36.), 759 (10.), 681 (2.)  
 beste Teiler: 48.7 (3.), 61.3 (7.), 81.8 (30.)  
 Trefferlage: 0.28 mm rechts, 1.47 mm tief  
 Streuwert: 2.73, horizontal: 2.54, vertikal: 2.91

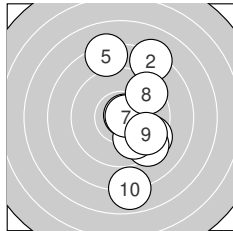
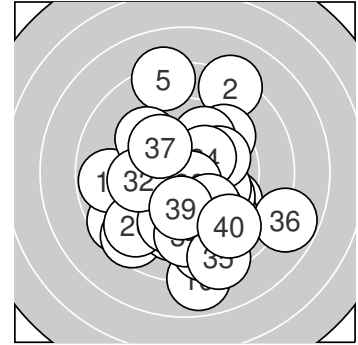

**Serie 1:**  
 9.4 ↘ 8.2 ↗ 10.8 \* 9.3 ↘ 8.2 ↑  
 9.9 ↘ 10.7 \* 9.5 ↗ 9.7 ↘ 7.9 ↓  
 beste Teiler: 48.7 (3.), 61.3 (7.), 261.0 (6.)  
 Trefferlage: 1.66 mm rechts, 0.10 mm tief  
 Streuwert: 3.21, horizontal: 1.56, vertikal: 4.26

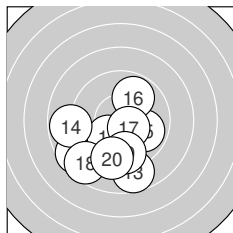

**Serie 2:**  
 8.6 ↙ 10.1 ↙ 8.7 ↓ 8.8 ← 9.9 →  
 9.9 ↗ 10.5 \* 8.6 ↙ 9.6 ↓ 9.3 ↓  
 beste Teiler: 116.0 (17.), 216.0 (12.), 267.1 (15.)  
 Trefferlage: 0.95 mm links, 2.27 mm tief  
 Streuwert: 2.55, horizontal: 2.74, vertikal: 2.34

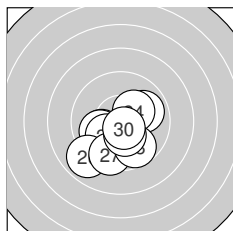

**Serie 3:**  
 10.1 ↙ 10.0 ↙ 9.9 → 10.3 \* 10.1 ↙  
 8.9 ↙ 9.5 ↓ 9.7 ↘ 10.3 \* 10.6 \*  
 beste Teiler: 81.8 (30.), 154.9 (29.), 173.4 (24.)  
 Trefferlage: 0.41 mm links, 1.36 mm tief  
 Streuwert: 1.78, horizontal: 1.91, vertikal: 1.63

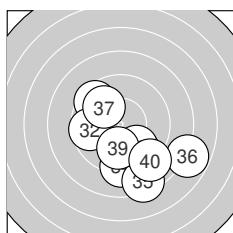

**Serie 4:**  
 9.5 ↘ 9.6 ← 9.5 ↘ 9.2 ↓ 8.4 ↓  
 7.8 → 9.9 ↘ 9.8 ↘ 9.9 ↓ 9.0 ↘  
 beste Teiler: 253.1 (37.), 254.5 (39.), 291.0 (38.)  
 Trefferlage: 0.83 mm rechts, 2.18 mm tief  
 Streuwert: 2.89, horizontal: 3.10, vertikal: 2.67



**Ergebnis:** **380.9** (362)  
**Serien:** 95.1 97.9 95.6 92.3  
**Zähler:** 11 22 5 2 0 0 0 0 0 0  
**Innenzehner:** 5  
**Weiteste:** 797 (34.), 788 (8.), 670 (36.)  
**beste Teiler:** 74.6 (12.), 75.6 (1.), 162.2 (16.)  
**Trefferlage:** 0.32 mm rechts, 0.11 mm tief  
**Streuwert:** 2.82, horizontal: 2.92, vertikal: 2.72

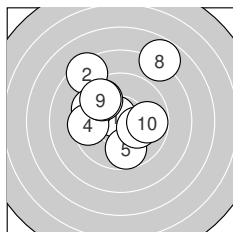
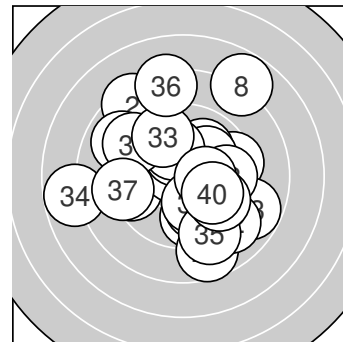

**Serie 1:**  
 10.7 \*                      8.4 ↘                      9.6 ↖                      9.5 ←                      9.7 ↓  
                                  9.7 ↘                      10.2 \*                      7.8 ↗                      9.7 ↘                      9.8 →

**beste Teiler:** 75.6 (1.), 192.4 (7.), 290.2 (10.)  
**Trefferlage:** 0.55 mm links, 1.42 mm hoch  
**Streuwert:** 2.84, horizontal: 2.83, vertikal: 2.85

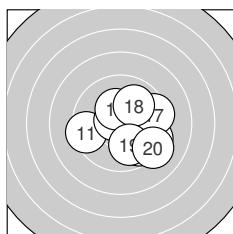

**Serie 2:**  
 9.4 ←                      10.7 \*                      9.8 ↘                      9.4 →                      9.7 ↓  
 10.3 \*                      9.5 →                      10.0 ↗                      9.9 ↓                      9.2 ↘

**beste Teiler:** 74.6 (12.), 162.2 (16.), 240.8 (18.)  
**Trefferlage:** 1.21 mm rechts, 0.74 mm tief  
**Streuwert:** 2.07, horizontal: 2.33, vertikal: 1.77

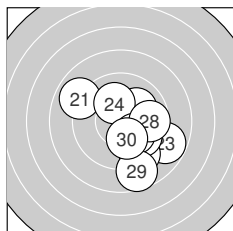

**Serie 3:**  
 8.9 ↘                      10.1 ↗                      8.8 →                      10.1 ↑                      9.3 ↓  
                                  9.8 ↘                      10.1 ↘                      9.7 →                      8.7 ↓                      10.1 ↓

**beste Teiler:** 201.2 (30.), 206.7 (27.), 207.1 (24.)  
**Trefferlage:** 1.29 mm rechts, 1.04 mm tief  
**Streuwert:** 2.49, horizontal: 2.47, vertikal: 2.51

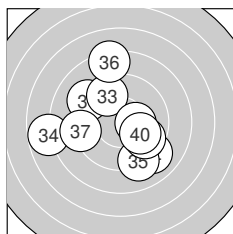

**Serie 4:**  
 9.2 ↘                      9.0 ↘                      9.7 ↖                      7.8 ←                      9.1 ↓  
                                  8.3 ↑                      9.2 ←                      9.7 ↘                      10.3 \*                      10.0 →

**beste Teiler:** 163.3 (39.), 246.3 (40.), 317.0 (38.)  
**Trefferlage:** 0.67 mm links, 0.10 mm tief  
**Streuwert:** 3.46, horizontal: 3.69, vertikal: 3.22



Ergebnis: **351.1** (333)  
 Serien: 95.7 89.0 81.6 84.8  
 Zähler: 6 12 14 5 3 0 0 0 0 0  
 Innenzehner: 6  
 Weitester: 1112 (35.), 1102 (30.), 1019 (14.)  
 beste Teiler: 58.0 (20.), 76.6 (16.), 93.0 (5.)  
 Trefferlage: 0.00 mm , 2.12 mm hoch  
 Streuwert: 4.09, horizontal: 4.76, vertikal: 3.28

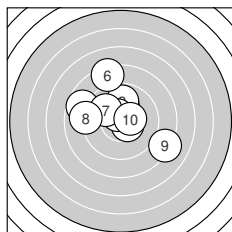
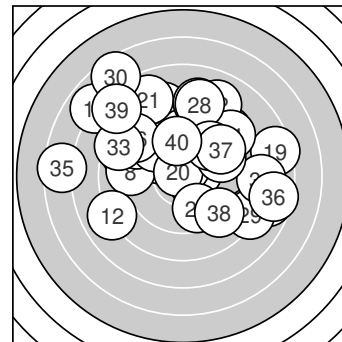

**Serie 1:**  
 10.2 \*                      9.9 ↑                      10.5 \*                      8.7 ↖                      10.6 \*  
    8.3 ↑                      9.9 ↘                      9.0 ←                      8.2 ↘                      10.4 \*  
 beste Teiler: 93.0 (5.), 109.4 (3.), 137.0 (10.)  
 Trefferlage: 0.52 mm links, 1.22 mm hoch  
 Streuwert: 2.90, horizontal: 3.26, vertikal: 2.48

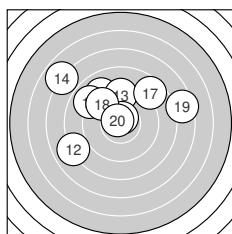

**Serie 2:**  
 9.0 ↘                      8.0 ↖                      9.4 ↑                      6.9 ↘                      8.9 ↘  
 10.6 \*                      8.6 ↗                      9.5 ↘                      7.4 →                      10.7 \*  
 beste Teiler: 58.0 (20.), 76.6 (16.), 366.3 (18.)  
 Trefferlage: 1.16 mm links, 2.37 mm hoch  
 Streuwert: 3.94, horizontal: 4.88, vertikal: 2.70

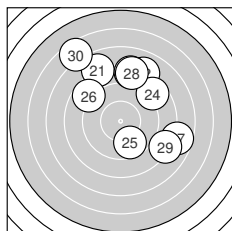

**Serie 3:**  
 7.9 ↘                      8.0 ↗                      8.2 ↑                      8.6 ↗                      9.7 ↘  
    8.7 ↘                      7.7 →                      8.2 ↑                      8.1 ↘                      6.5 ↘  
 beste Teiler: 320.1 (25.), 561.2 (26.), 579.9 (24.)  
 Trefferlage: 1.19 mm rechts, 3.45 mm hoch  
 Streuwert: 4.62, horizontal: 4.55, vertikal: 4.70



**Serie 4:**  
 8.1 →                      9.4 ↗                      8.4 ↘                      9.5 ↗                      6.5 ←  
    7.5 →                      9.2 ↗                      9.1 ↘                      7.5 ↘                      9.6 ↑  
 beste Teiler: 326.6 (40.), 372.5 (34.), 389.5 (32.)  
 Trefferlage: 0.46 mm rechts, 1.43 mm hoch  
 Streuwert: 4.85, horizontal: 6.28, vertikal: 2.74



Ergebnis: **393.1** (374)  
 Serien: 100.5 94.4 99.2 99.0  
 Zähler: 19 18 2 0 1 0 0 0 0 0  
 Innenzehner: 15  
 Weitester: 1075 (15.), 705 (29.), 637 (32.)  
 beste Teiler: 48.0 (1.), 67.1 (37.), 73.5 (39.)  
 Trefferlage: 0.80 mm rechts, 0.30 mm hoch  
 Streuwert: 2.36, horizontal: 2.88, vertikal: 1.67

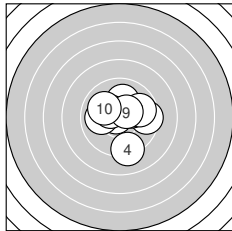
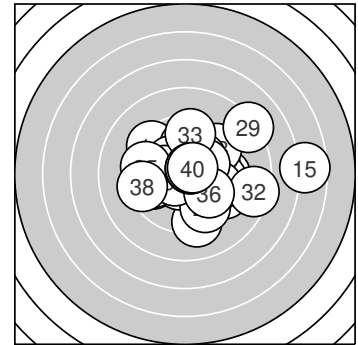

**Serie 1:**  
 10.8 \*                      9.5 →                      10.0 ←                      9.2 ↓                      10.2 \*  
 10.1 ↑                      9.8 ↗                      10.4 \*                      10.5 \*                      10.0 ↘  
 beste Teiler: 48.0 (1.), 117.2 (9.), 144.0 (8.)  
 Trefferlage: 0.40 mm rechts, 0.22 mm hoch  
 Streuwert: 1.85, horizontal: 1.97, vertikal: 1.72

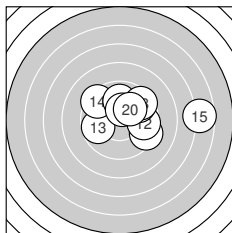

**Serie 2:**  
 9.4 ↘                      9.6 →                      9.7 ←                      9.4 ↘                      6.7 →  
 9.7 ↗                      9.9 ↑                      9.5 ↗                      10.4 \*                      10.1 ↗  
 beste Teiler: 144.0 (19.), 205.1 (20.), 259.0 (17.)  
 Trefferlage: 1.88 mm rechts, 0.97 mm hoch  
 Streuwert: 2.96, horizontal: 3.90, vertikal: 1.53

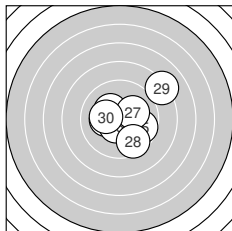

**Serie 3:**  
 10.5 \*                      10.3 \*                      10.2 \*                      9.9 ↘                      9.7 →  
 10.5 \*                      10.2 \*                      9.6 ↘                      8.1 ↗                      10.2 \*  
 beste Teiler: 107.3 (26.), 117.9 (21.), 171.1 (22.)  
 Trefferlage: 1.00 mm rechts, 0.00 mm  
 Streuwert: 2.17, horizontal: 2.39, vertikal: 1.93

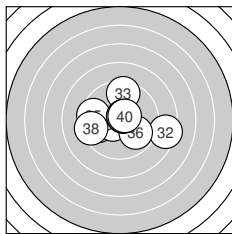

**Serie 4:**  
 9.8 ←                      8.4 →                      9.5 ↑                      10.5 \*                      9.5 ←  
 9.9 ↘                      10.7 \*                      9.4 ←                      10.7 \*                      10.6 \*  
 beste Teiler: 67.1 (37.), 73.5 (39.), 88.7 (40.)  
 Trefferlage: 0.06 mm links, 0.01 mm hoch  
 Streuwert: 2.38, horizontal: 2.98, vertikal: 1.55



Ergebnis: **378.2** (360)  
 Serien: 90.7 99.4 95.8 92.3  
 Zähler: 16 11 10 3 0 0 0 0 0 0  
 Innenzehner: 12  
 Weitester: 990 (8.), 828 (5.), 823 (21.)  
 beste Teiler: 37.1 (17.), 117.6 (3.), 132.4 (35.)  
 Trefferlage: 1.09 mm links, 1.42 mm tief  
 Streuwert: 2.85, horizontal: 3.19, vertikal: 2.46

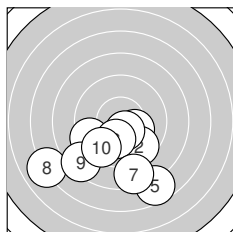
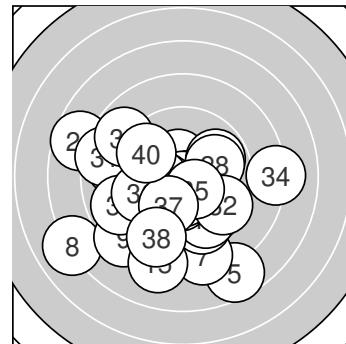

**Serie 1:**  
 10.2 \*                      9.5 ↘                      10.5 \*                      9.4 ↙                      7.6 ↘  
 10.1 ↓                      8.5 ↓                      7.0 ↙                      8.4 ↙                      9.5 ↙  
 beste Teiler: 117.6 (3.), 184.0 (1.), 208.8 (6.)  
 Trefferlage: 0.95 mm links, 3.48 mm tief  
 Streuwert: 3.05, horizontal: 3.71, vertikal: 2.19

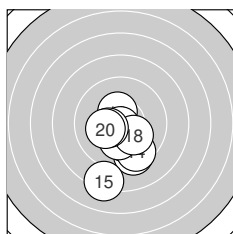

**Serie 2:**  
 9.4 ↘                      10.1 ↓                      10.4 \*                      9.5 ↘                      8.2 ↓  
 10.2 \*                      10.8 \*                      10.2 \*                      10.4 \*                      10.2 \*  
 beste Teiler: 37.1 (17.), 134.8 (13.), 147.4 (19.)  
 Trefferlage: 0.04 mm links, 1.90 mm tief  
 Streuwert: 1.82, horizontal: 1.34, vertikal: 2.19

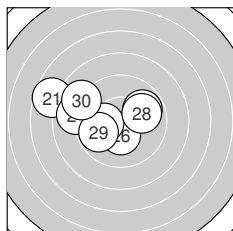

**Serie 3:**  
 7.7 ↖                      10.0 ←                      9.8 ↗                      8.9 ←                      10.3 \*  
 10.3 \*                      10.2 \*                      9.9 ↗                      9.8 ↙                      8.9 ↖  
 beste Teiler: 158.0 (26.), 174.4 (25.), 189.0 (27.)  
 Trefferlage: 2.05 mm links, 0.39 mm hoch  
 Streuwert: 2.49, horizontal: 3.21, vertikal: 1.46

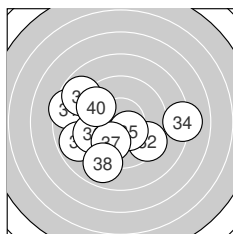

**Serie 4:**  
 8.5 ↖                      9.5 ↘                      8.9 ↙                      8.1 →                      10.4 \*  
 9.6 ↙                      10.0 ↓                      8.9 ↓                      8.8 ↖                      9.6 ↖  
 beste Teiler: 132.4 (35.), 248.6 (37.), 328.4 (40.)  
 Trefferlage: 1.32 mm links, 0.72 mm tief  
 Streuwert: 3.25, horizontal: 3.98, vertikal: 2.30



Ergebnis: **364.4** (348)  
 Serien: 93.1 93.8 87.7 89.8  
 Zähler: 8 18 9 4 1 0 0 0 0 0  
 Innenzehner: 5  
 Weitestе: 1129 (25.), 889 (36.), 839 (39.)  
 beste Teiler: 10.8 (35.), 115.6 (32.), 126.6 (18.)  
 Trefferlage: 0.62 mm rechts, 1.13 mm hoch  
 Streuwert: 3.58, horizontal: 3.93, vertikal: 3.19

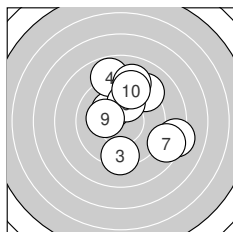
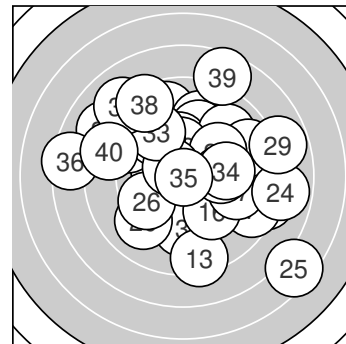

**Serie 1:**  
 8.2 → 10.3 \* 9.3 ↓ 8.8 ↑ 9.2 ↗  
 10.0 ↑ 8.6 → 9.1 ↑ 10.2 \* 9.4 ↑  
 beste Teiler: 174.7 (2.), 184.1 (9.), 226.2 (6.)  
 Trefferlage: 1.35 mm rechts, 1.19 mm hoch  
 Streuwert: 2.99, horizontal: 2.81, vertikal: 3.17

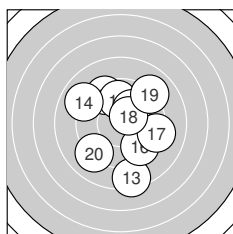

**Serie 2:**  
 9.4 ↘ 9.8 ↑ 8.3 ↓ 9.0 ↖ 10.1 ↗  
 9.5 ↘ 9.2 → 10.4 \* 9.0 ↗ 9.1 ↖  
 beste Teiler: 126.6 (18.), 212.6 (15.), 278.7 (12.)  
 Trefferlage: 0.37 mm rechts, 0.07 mm hoch  
 Streuwert: 3.08, horizontal: 2.77, vertikal: 3.36

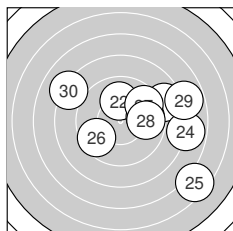

**Serie 3:**  
 8.7 → 10.0 ↑ 9.8 → 7.9 → 6.4 ↘  
 9.6 ↖ 9.6 ↗ 9.8 → 7.8 → 8.1 ↖  
 beste Teiler: 237.6 (22.), 293.4 (23.), 297.2 (28.)  
 Trefferlage: 2.83 mm rechts, 0.28 mm hoch  
 Streuwert: 4.05, horizontal: 4.77, vertikal: 3.16

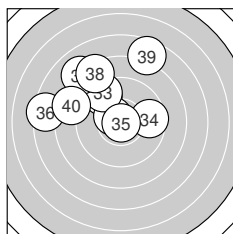

**Serie 4:**  
 9.5 ↘ 10.5 \* 9.3 ↘ 9.6 → 10.9 \*  
 7.4 ← 8.1 ↘ 8.4 ↘ 7.6 ↑ 8.5 ↖  
 beste Teiler: 10.8 (35.), 115.6 (32.), 340.4 (34.)  
 Trefferlage: 2.08 mm links, 2.96 mm hoch  
 Streuwert: 3.27, horizontal: 3.79, vertikal: 2.64



Ergebnis: **378.4** (361)  
 Serien: 94.8 94.3 95.5 93.8  
 Zähler: 11 20 8 1 0 0 0 0 0 0  
 Innenzehner: 7  
 Weitester: 889 (30.), 747 (6.), 659 (31.)  
 beste Teiler: 104.5 (10.), 109.6 (36.), 169.0 (29.)  
 Trefferlage: 0.44 mm rechts, 0.68 mm hoch  
 Streuwert: 2.90, horizontal: 3.15, vertikal: 2.62

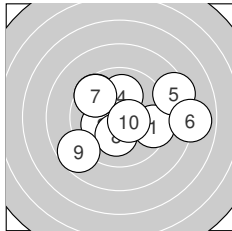
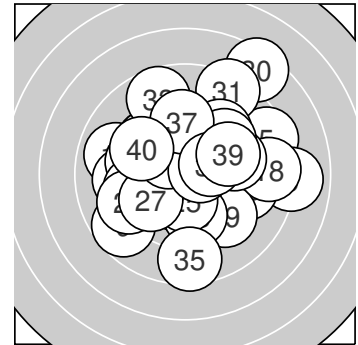

**Serie 1:**  
 9.5 → 10.2 \* 9.6 ↘ 10.0 ↑ 8.5 →  
 8.0 → 9.6 ↘ 10.2 \* 8.7 ↙ 10.5 \*  
 beste Teiler: 104.5 (10.), 189.2 (8.), 199.4 (2.)  
 Trefferlage: 0.63 mm rechts, 0.13 mm hoch  
 Streuwert: 3.10, horizontal: 3.85, vertikal: 2.09

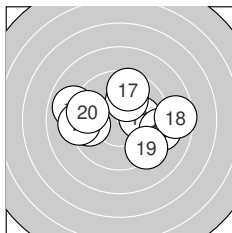

**Serie 2:**  
 10.1 → 9.7 ← 9.2 → 10.1 ↑ 8.9 ←  
 9.2 ← 9.6 ↑ 8.6 → 9.3 ↘ 9.6 ←  
 beste Teiler: 216.5 (11.), 224.2 (14.), 324.5 (12.)  
 Trefferlage: 0.11 mm rechts, 0.34 mm hoch  
 Streuwert: 2.95, horizontal: 3.81, vertikal: 1.71

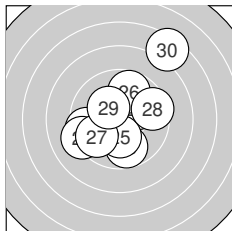

**Serie 3:**  
 9.5 ← 9.2 ← 9.8 ↓ 10.1 → 10.2 \*  
 9.7 ↑ 9.8 ↙ 9.5 → 10.3 \* 7.4 ↗  
 beste Teiler: 169.0 (29.), 184.0 (25.), 215.0 (24.)  
 Trefferlage: 0.10 mm rechts, 0.41 mm hoch  
 Streuwert: 2.99, horizontal: 2.93, vertikal: 3.06

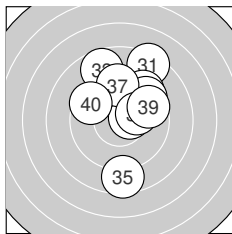

**Serie 4:**  
 8.3 ↗ 9.4 ↗ 8.7 ↖ 9.5 ↗ 8.6 ↓  
 10.5 \* 9.5 ↑ 10.2 \* 9.6 → 9.5 ↘  
 beste Teiler: 109.6 (36.), 193.7 (38.), 335.1 (39.)  
 Trefferlage: 0.93 mm rechts, 1.84 mm hoch  
 Streuwert: 2.78, horizontal: 2.13, vertikal: 3.31



Ergebnis: **371.1** (355)  
 Serien: 94.6 88.5 92.3 95.7  
 Zähler: 13 17 7 2 0 0 0 0 1 0  
 Innenzehner: 8  
 Weitester: 2074 (18.), 843 (2.), 790 (22.)  
 beste Teiler: 16.4 (29.), 70.7 (32.), 77.0 (4.)  
 Trefferlage: 0.21 mm rechts, 0.65 mm tief  
 Streuwert: 3.79, horizontal: 3.84, vertikal: 3.74

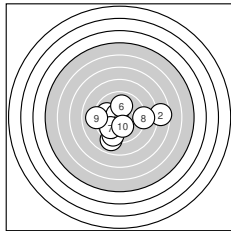
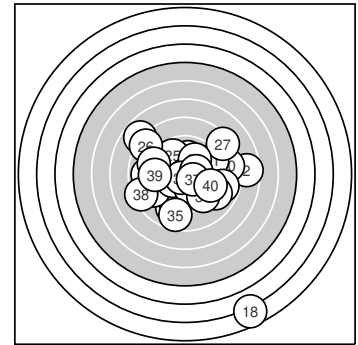

**Serie 1:**  
 9.9 ←                      7.6 →                      9.0 ↓                      10.6 \*                      9.4 ↓  
 10.0 ↑                      9.8 ↙                      9.0 →                      9.1 ←                      10.2 \*  
 beste Teiler: 77.0 (4.), 194.1 (10.), 235.5 (6.)  
 Trefferlage: 0.15 mm rechts, 0.82 mm tief  
 Streuwert: 3.12, horizontal: 3.85, vertikal: 2.16

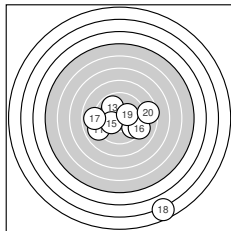

**Serie 2:**  
 9.0 ↙                      10.1 ↘                      9.9 ↘                      9.7 ↘                      10.2 \*                      10.2 \*  
 9.2 ↘                      8.9 ←                      2.7 ↓                      10.2 \*                      8.6 →  
 beste Teiler: 176.7 (19.), 191.5 (15.), 205.6 (12.)  
 Trefferlage: 0.88 mm rechts, 2.04 mm tief  
 Streuwert: 5.35, horizontal: 4.53, vertikal: 6.06

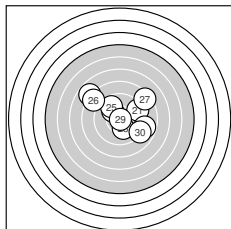

**Serie 3:**  
 9.3 ↗                      7.8 ↘                      10.1 ↘                      8.8 →                      9.7 ↘  
 8.3 ↘                      8.3 ↗                      10.1 ↓                      10.9 \*                      9.0 →  
 beste Teiler: 16.4 (29.), 202.4 (28.), 218.4 (23.)  
 Trefferlage: 0.45 mm rechts, 1.30 mm hoch  
 Streuwert: 3.50, horizontal: 4.13, vertikal: 2.72

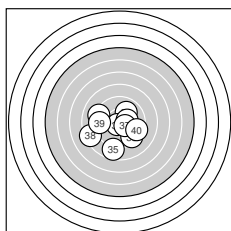

**Serie 4:**  
 10.0 ↗                      10.7 \*                      9.4 ↘                      10.3 \*                      8.7 ↓  
 9.2 ↘                      10.4 \*                      8.3 ↙                      9.3 ←                      9.4 →  
 beste Teiler: 70.7 (32.), 130.0 (37.), 158.3 (34.)  
 Trefferlage: 0.62 mm links, 1.03 mm tief  
 Streuwert: 2.78, horizontal: 3.21, vertikal: 2.27

